

Artikel-Nr.	<b>2922-4v</b>
Bezeichnung	<b>CEE-Kupplung 32A 2p 24/42VAC 100-200Hz IP67 TWIST</b>
Langbeschreibung	CEE-Kupplung 32A2p 24/42VAC 100-200Hz IP67 TWIST Gehäusematerial: PA6 Nennstrom: 32A Polzahl: 2 (2P) Uhrzeit-Stellung: 4h Nennspannung/Frequenz: 24/42V~ / 100-200Hz Kontakte: Messing vernickelt Anschlusstechnik: Schraubklemmen Schutzart: IP67
GTIN (EAN)	9003399486241
Ursprungsland	AT
Zolltarifnummer	85366990
Nettogewicht	0,203 kg
Verpackungsmenge	10
Mindestbestellmenge	10

ETIM 9.0	EC001320
IEC-Stromstärke	32 A
Polzahl	2
Spannung nach EN 60309-2	20-25 V / 40-50 V (100-200 Hz) grün
Uhrzeit-Stellung	4 h
Schutzart (IP)	IP67
Anschlusstechnik	Schraubklemme
Steckrichtung	gerade
Kabeleinführung	Verschraubung
Werkstoff	Kunststoff

a	150 mm
b	78 mm
K (Kabel Ø)	9,5-24 mm
SW	48 mm
Leitung flexibel	1-10 mm <sup>2</sup>
Kontaktschrauben	160 Ncm
Zugentlastung	600 Ncm
Abmantelungslänge	70 mm
Abisolierlänge	14-16 mm
Umgebungstemperatur	-25 – 40 °C
Temperaturbeständigkeit	-25 – 80 °C

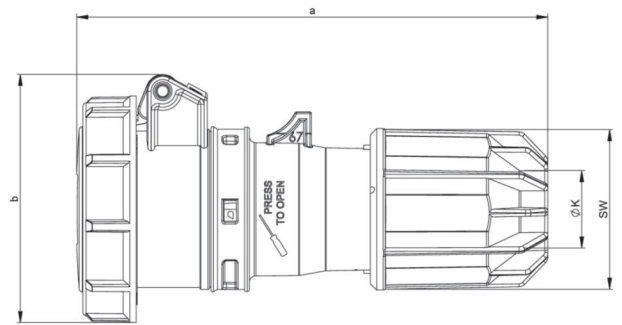





<https://www.pcelectric.at/shop/de/?func=detail&artnr=2922-4v>