

DEHNventil modular DV M2 TNS 255 FM

- DE Einbauanleitung
- GB Installation instructions
- IT Istruzioni di montaggio
- FR Instructions de montage
- NL Montagehandleiding
- ES Instrucciones de montaje
- PT Instruções de montagem
- DK Monteringsvejledning
- SE Monteringsanvisning
- FI Asennusohje
- GR Οδηγίες συναρμολόγησης
- PL Instrukcja montażu
- CZ Návod k montáži
- TR Montaj kılavuzu
- RU Инструкция по монтажу
- CN 安装说明
- HU Szerelési útmutató
- JP 設置説明書



I+II+III IEC 61643-11...
1+2+3 EN 61643-11...

PZ 2 (4 Nm)

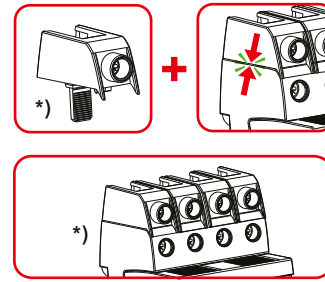
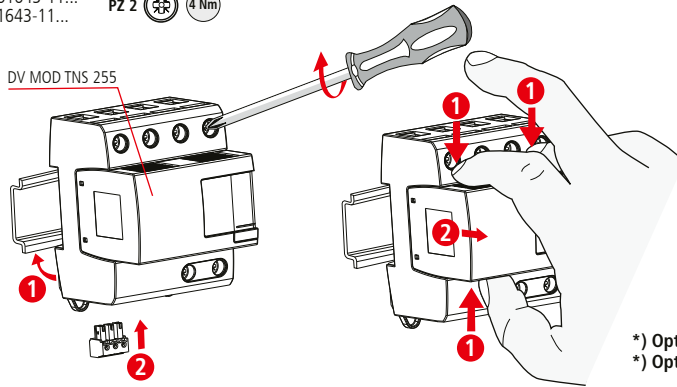
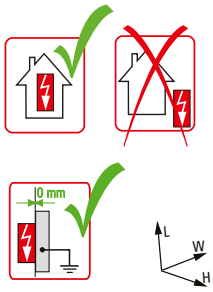

*) Optional available, **STAK25** (Part No. 952 589) for serial connection
*) Optional erhältlich, **STAK25** (Art.-Nr. 952 589) für serielle Verdrahtung

DV M2 TNS 255 FM	
	DV MOD TNS 255
$U_N / \text{ToI: } \pm 10\%$	230 / 400 V (50/60 Hz)
U_C	255 V (50/60 Hz)
I_N	50 kA _{rms}
I_{SCCR}	50 kA _{rms}
$I_{imp} 10/350 \mu s$	25 kA (L/N→PE); 100 kA (L1+L2+L3+N→PE)
$I_n 8/20 \mu s$	25 kA (L/N→PE); 100 kA (L1+L2+L3+N→PE)
U_{OC}	6 kV
max. \equiv 1)	100 A gG
max. \equiv 2)	250 A gG
θ	-40°C ... +80°C (... +60°C ?)
I_{PE}	<< 10 μ A
Φ	5% ... 95%
IP 3)	20
L x W x H	90 mm x 72 mm x 66 mm

1) TNS

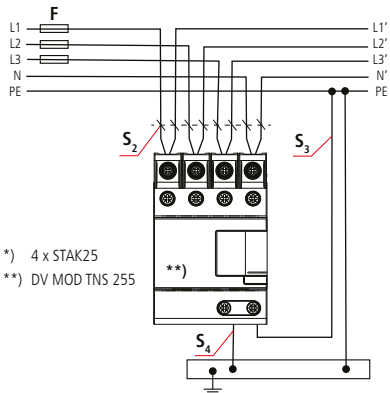

*) 4 x STAK25
**) DV MOD TNS 255

DEHNventil modular DV M2 TNS 255 FM	
F	$F \leq 100 \text{ A gG}$
	$F > 100 \text{ A gG}$

F A gG	S ₂ / mm ²	S ₃ / mm ²	S ₄ / mm ²
25	6	16	16
35	6	16	16
40	6	16	16
50	10	16	16
63	10	16	16
80	16	16	16
100	25	16	16

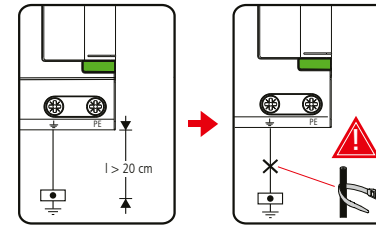

	16 mm	16 mm	16 mm
min. \square L1, L2, L3, N, PE, \downarrow	6 mm ²		
max. \square L1, L2, L3, N, PE, \downarrow	25 mm ² 4)	35 mm ²	
\square	16 mm ² Cu $\geq 15.5 \text{ mm}$		

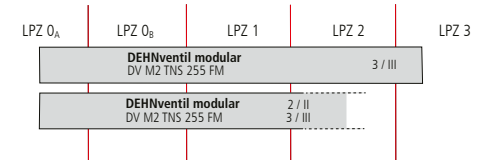

2) TNS

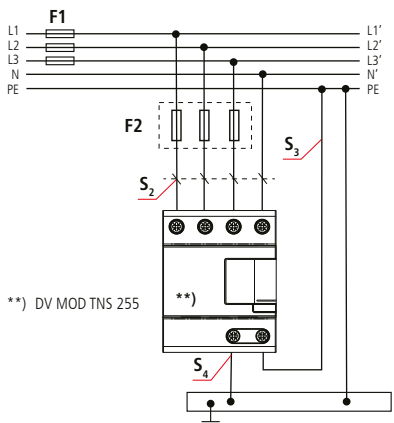

**) DV MOD TNS 255

DEHNventil modular DV M2 TNS 255 FM	
F1	$F1 > 250 \text{ A gG}$
	$F2 \leq 250 \text{ A gG}$
F2	$F1 \leq 250 \text{ A gG}$
	$F2$

F1 A gG	S ₂ / mm ²	S ₃ / mm ²	S ₄ / mm ²	F2 A gG
25	6	16	16	---
35	6	16	16	---
40	6	16	16	---
50	6	16	16	---
63	10	16	16	---
80	10	16	16	---
100	16	16	16	---
125	16	16	16	---
160	16	16	16	---
200	25	25	25	---
250	25	25	25	---
>250	25	25	25	250

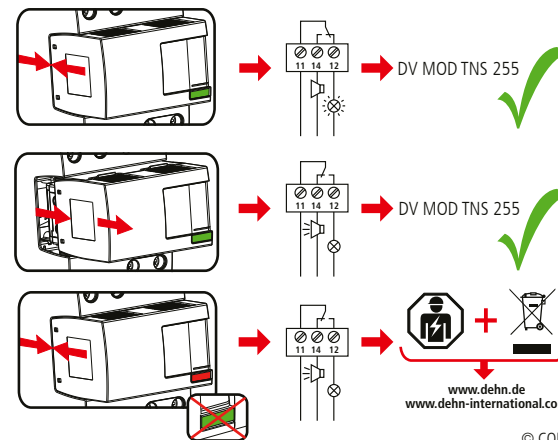

DEHNventil modular DV M2 TNS 255 FM	
U_N / I_N	AC: 250 V / 0.5 A
	DC: 250 V / 0.1 A 125 V / 0.2 A 75 V / 0.5 A
max. 1.5 mm ²	

