

lightnet

Matric-R6

Pendant light-line - Direct/indirect light distribution

Article code: LR6AEE-840M-L1182-Y

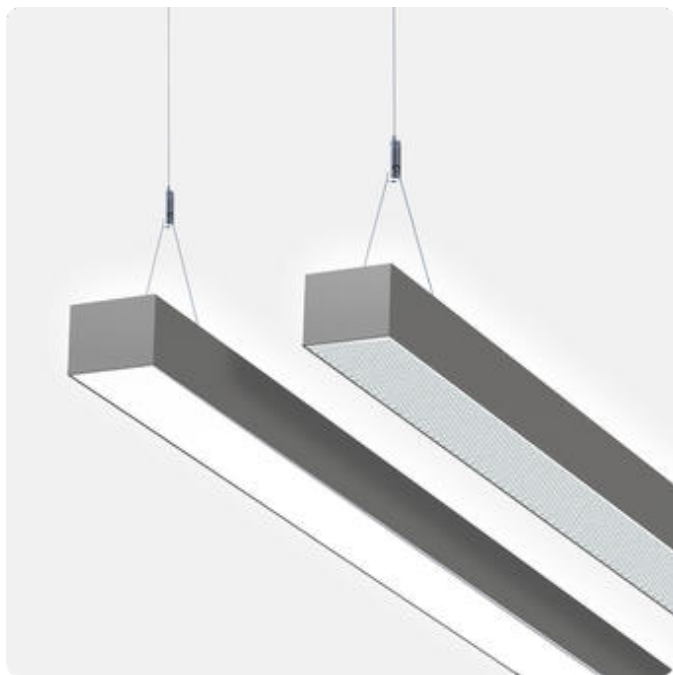

Illustrations may only be similar and serve as an orientation.

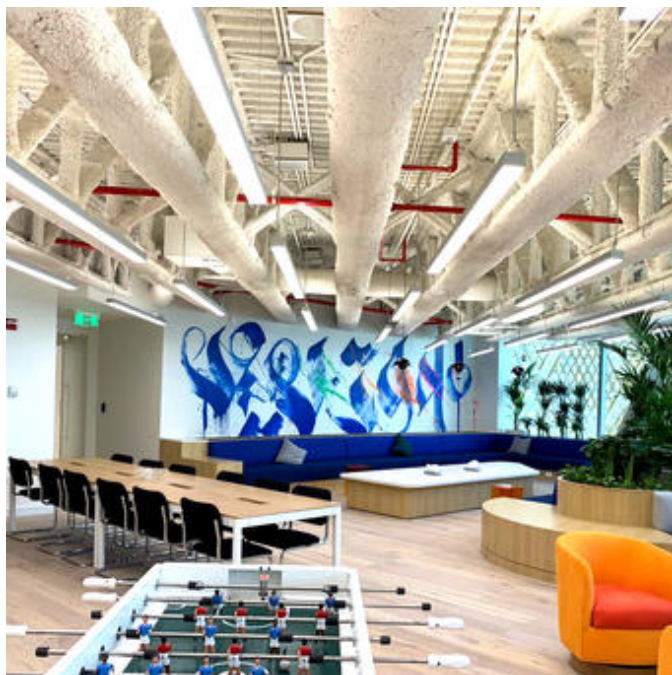

Matric-R6. LED. Pendant light-line. Luminaire body made of high-quality aluminum profile. Surface finish Silver Anodised. Direct/indirect light distribution. Colour temperature: 4000K (Cool White). Colour Rendering Index (CRI): >80. Microprismatic screen for uniform illumination and reduced luminance in office areas. UGR<=19. Switchable. LxWxH (rectangular). L=1182mm. W=81mm. H=60mm. Y-cord suspension with power supply cable and ceiling rose (Set). Pendant length max 1500mm. Power

supply: transparent. Ceiling rose: Matching luminaire's surface colour. Medium-power current. 5710lm. 44W. 4,3kg. Binning initial <= MacAdam 3. IP20. Protection class I. CE, UKCA marking. Prüfzeichen: ENEC. IK02. 220-240V. 50-60 Hz. RG0 (EN62471). Luminous flux reduction up to 0,3%/1.000 operating hours. Nominal failure rate: 0,2%/1.000 operating hours. L85B10 (tq 25°C) = 50.000h. 5 years warranty. Manufacturer: Lightnet GmbH, ISO 9001:2015 and 50001:2018 certified.

lightnet

Matric-R6

Pendant light-line - Direct/indirect light distribution

Article code: LR6AEE-840M-L1182-Y

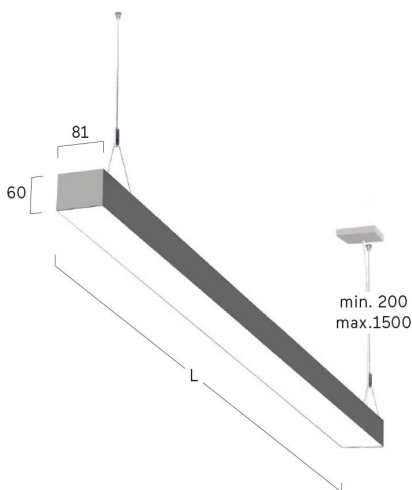
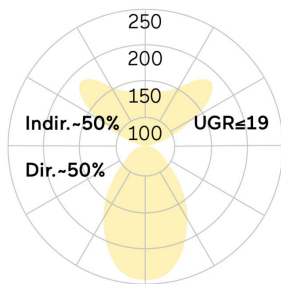

Customer / Project: _____

Note: _____

Productname	Matric-R6
Lamp	LED
Installation Type	Pendant light-line
Surface finish	Silver Anodised
Light characteristics	Direct/indirect light distribution
Colour temperature	4000K
Colour Rendering Index (CRI)	CRI>80
Optical system	Microprismatic screen
Control	Switchable
Length L/Diameter D (mm)	L=1182mm
Width W (mm)	W=81mm
Height H (mm)	H=60mm
Current/Power	Medium-Power
Luminous Flux	5710lm
Power consumption	44W
Suspension	Y-susp. (Set)
Ceiling rose colour	Ceiling rose: Matching luminaire`s surface colour
Pendant length (mm)	Pendant length max 1500mm
Degree of protection	IP20
Certification	Prüfzeichen: ENEC
Cable Colour	Power supply: transparent
LED lifetime	L85B10 (tq 25°C) = 50.000h
UGR	UGR<=19
Photometric code	8 40 / 3 3 9
Photobiological class	RG0 (EN62471)
Indoor/Outdoor	Indoor: ta [ambient] max. 25°C
Weight (kg)	4,3kg

