

LED reflector insert MR16, 6 W, 350 mA
Article no. 12924604

Light.
For Generations.

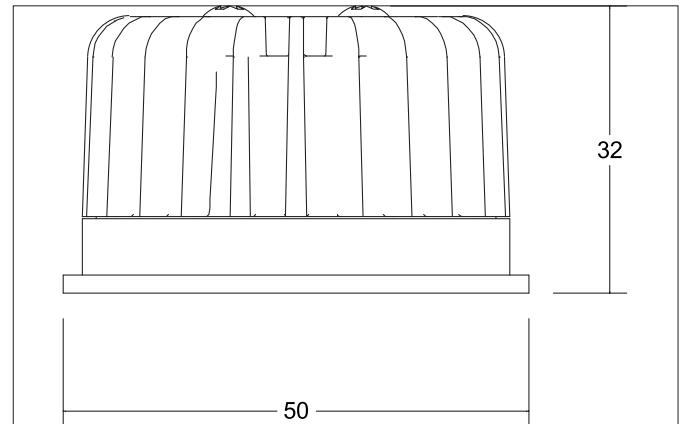

Tender

LED reflector insert MR16, 6 W, 350 mA, Round. Ceiling cut-out Installation depth mm, Outer diameter 50 mm, Weight 0,078 kg, with rotationssymmetrical, deep, wide distributed light intensity. with Lamp holder Plug&Play max: 6 W, Delivery without bulb. Housing material: Aluminium / Glass, Colour:, Permissible ambient temperature (ta): -20 °C - +25 °C, Protection class (EN 61140): III, Degree of protection (DIN EN 60529): IP20. For direct connection to mains voltage, Dimming depending on driver dimmable.

Article data	
Article no.	12924604
GTIN	4251433936251
Short description	LED reflector insert MR16, 6 W, 350 mA
Material	Aluminium / Glass
Colour	
Shape	Round
Outer diameter	50 mm
Hight	32 mm
Weight	0.078 kg

LED reflector insert MR16, 6 W, 350 mA
Article no. 12924604

Light.
For Generations.











Lighting technology	
Colour temperature	3500 K
Light colour	White
Luminous flux	660 lm
System efficiency	110 lm/W
Colour rendering	CRI > 80
Reflector	High-gloss
Beam angle	60°
Light sharing	Symmetric

Operating technology of the luminaire	
Voltage type	DC
Current	350 mA
Lamp	LED
Lamp holder	Plug&Play
Protection class	III
Degree of protection	IP20
Control	Dimming depending on driver
Bulb change possible	Yes
Rated life time L80/B20 at 25 °C	50.000 h

Packing data	
Gross weight	0.089 kg
Length of packaging	55 mm
Packaging width	55 mm
Packaging height	65 mm
Disposal at end of life	This product must not be disposed of with household waste. You are obliged, to dispose of such electrical waste separately. By disposing of electrical waste and other old or defective electronics separately, you support recycling or other forms of re-use. In that way you help to take care and to avoid that harmful substances get into the environment.

LED reflector insert MR16, 6 W, 350 mA
Article no. 12924604

Light.
For Generations.

Accessories	
	Article no.: 17662020 LED converter 350 mA, on/off switchable Power: 1 - 7,2 W Dimensions: 68 mm x 35 mm x 21 mm
	Article no.: 17613000 LED converter 350 mA, on/off switchable Power: 1 - 15 W Dimensions: 115 mm x 34 mm x 19 mm
	Article no.: 17621020 LED converter 350 mA, on/off switchable Power: 1 - 21 W Dimensions: 128 mm x 50 mm x 13 mm
	Article no.: 17663020 LED converter 350 mA, trailing-edge phase dimmable Power: 2,8 - 7 W Dimensions: 110 mm x 50 mm x 19 mm
	Article no.: 17652020 LED-round converter 350 mA, trailing-edge phase dimmer Power: 4,9 - 7 W Dimensions: 51 mm x 24 mm
	Article no.: 17640020 LED converter 350 mA, trailing-edge phase dimmable Power: 4,2 - 10 W Dimensions: 102 mm x 38 mm x 21 mm
	Article no.: 17657000 LED converter 350 mA, 1-10 V dimmable (analog) Power: 5,2 - 18 W Dimensions: 110 mm x 52 mm x 22 mm
	Article no.: 17683020 LED converter 350 mA, DALI dimmable (digital) Power: 3,5 - 17 W Dimensions: 110 mm x 52 mm x 22 mm
	Article no.: 17648020 LED converter 350 mA, trailing-edge phase dimmable Power: 0,7 - 17 W Dimensions: 166 mm x 46 mm x 34 mm
	Article no.: 17671020 LED converter 350mA, ZigBee dimmable Power: 3,5 - 18,5 W Dimensions: 146 mm x 44 mm x 30 mm