

③ 0.75 - 1.5mm²

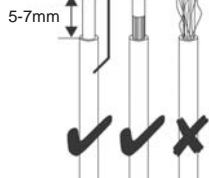

CKIT

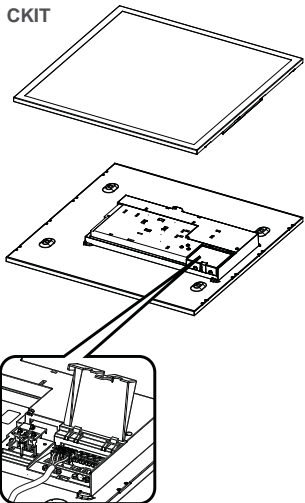

CKIT +

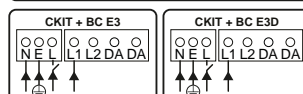
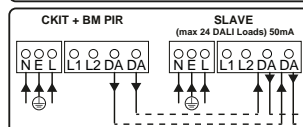
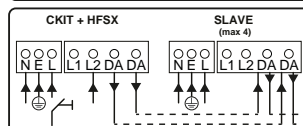
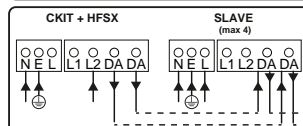
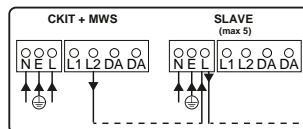
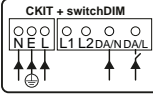
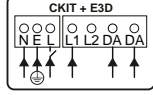
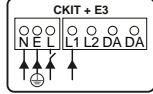
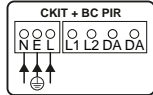
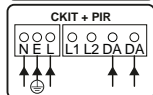
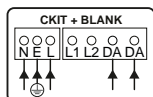
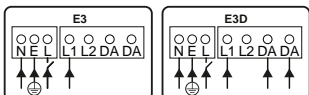
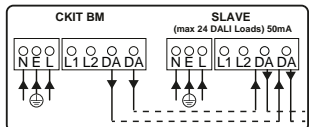
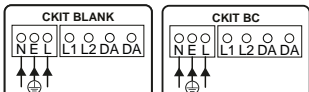
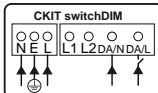
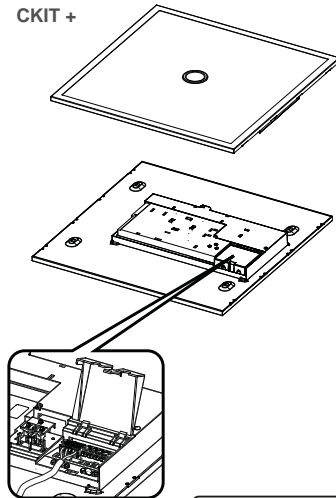

THORN

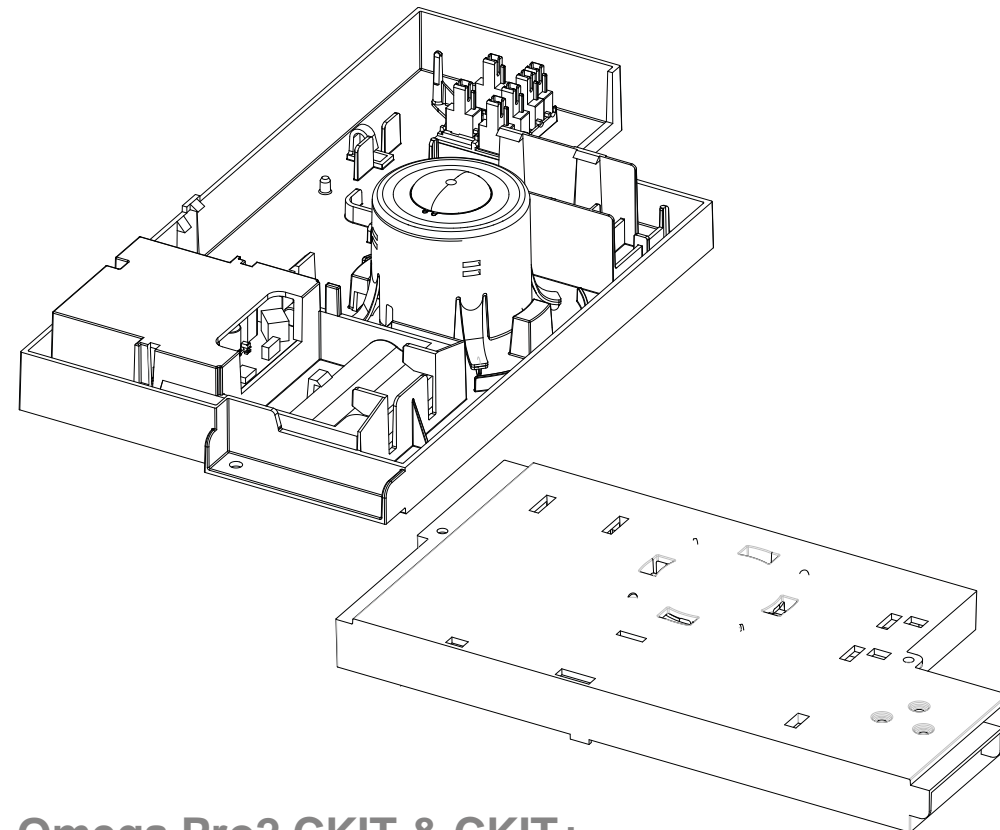

Omega Pro2 CKIT & CKIT+



- [CZ] Montážní návod
- [DE] Montageanleitung
- [DK] Monteringsvejledning
- [EE] Paigaldusjuhend
- [FI] Asennusohje
- [FR] Notice de montage
- [HU] Szerelési útmutató
- [IT] Istruzioni di montaggio

- [LT] Montavimo Instrukcijos
- [LV] Instalācijas instrukcija
- [NO] Monteringsanvisning
- [PL] Instrukcja montażu
- [RU] Инструкция по монтажу
- [SE] Installationsanvisning
- [UK] Installation Instructions

1

iv

C KIT + E3 → 2

? → 3

Description	SAP Code
OP2 CKIT BC	96633180
OP2 CKIT BLANK	96633178
OP2 CKIT BM	96633179
OP2 CKIT+ BC	96633270
OP2 CKIT+ BC E3	96633263
OP2 CKIT+ BC E3D	96633264
OP2 CKIT+ BC PIR	96633186
OP2 CKIT+ BLANK	96633181
OP2 CKIT+ BM	96633269
OP2 CKIT+ BM PIR	96633185
OP2 CKIT+ E3	96633187
OP2 CKIT+ E3D	96633188
OP2 CKIT+ HFSX	96633268
OP2 CKIT+ MWS	96633182
OP2 CKIT+ PIR DALI-M-SENSOR G2	96633183
OP2 CKIT+ PIR DALI-M-SENSOR G3	96633184

A

3

i

Click

ii

iii

x2

iv

HFSX → 96357206

BC → 96400634

MWS → 96356093

BM → 63400283

2

E3/E3D ?

i

ii

iii

iv

v

S

E

A

a

b

a

b

C KIT + E3 / E3D

i

Click

ii

iii

Click

iv

Click

< 3h

59010611 – LiFePO4 Lithium Iron Battery