

Weitergabe sowie Vervielfältigung dieses Dokuments, Verwertung und Mitteilung seines Inhalts sind verboten, soweit nicht ausdrücklich gestattet. Zuwiderhandlungen verpflichten zu Schadensersatz. Alle Rechte für den Fall der Patent-, Gebrauchsmuster- oder Designeintragung vorbehalten. Bauartbedingtes Spiel ist in den Toleranzangaben nicht berücksichtigt.

Transfer or duplication of this document as well as the utilisation or communication of its content are not permitted unless express consent is granted. Violations give rise to claims for damages. All rights reserved in case of patent, utility model or design patent registrations. Tolerance specifications do not include clearances inherent in the design.

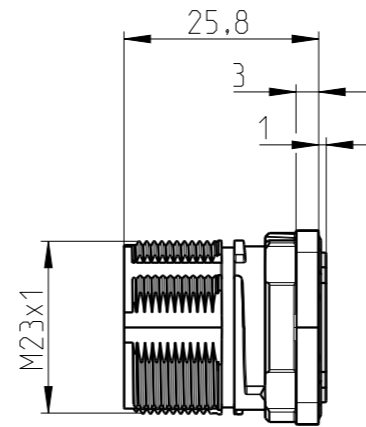

plug face male

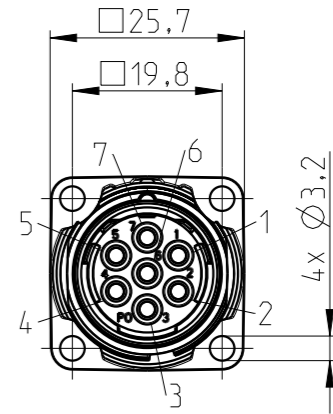

delivering status

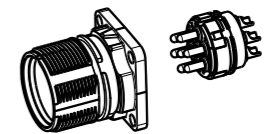

1:2

	document-No. / RI	date	scale	- Simplified representation - Document excluded from change process - Linear dimensions [mm] - EN ISO 291 23/50
	097104307 /00	17.06.21	1:1	
	document-type			
	TECDOC 2D-Productfamily			
description				
M23-07PIN12W500S				
page 1	of 1			