







Art.-Nr.: 710.51 

PLIR 03/22

 



2x  2x  2x 

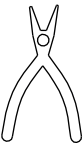

 Not incl.

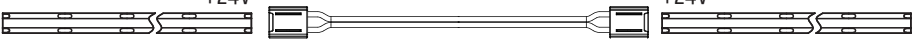

A



DC 24V 
Max. 6A 144W

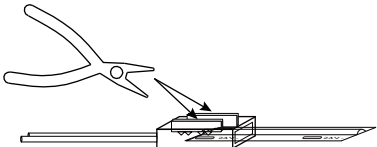

+24V    +24V

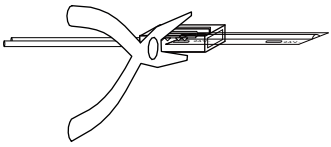

 









 



 

  

B

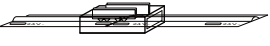

DC 24V 
Max. 6A 144W

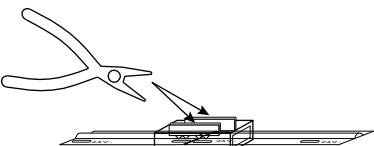

+24V    +24V

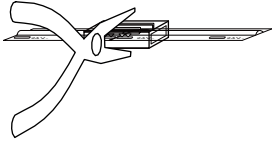

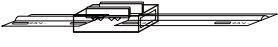

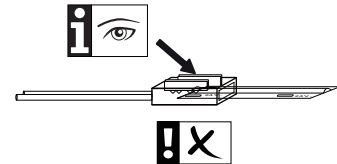

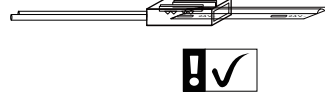
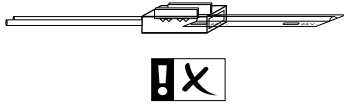
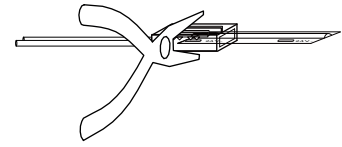
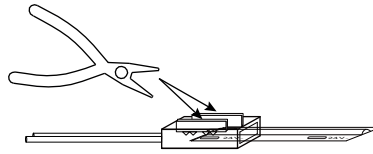
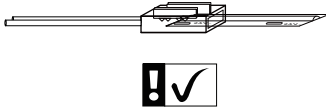
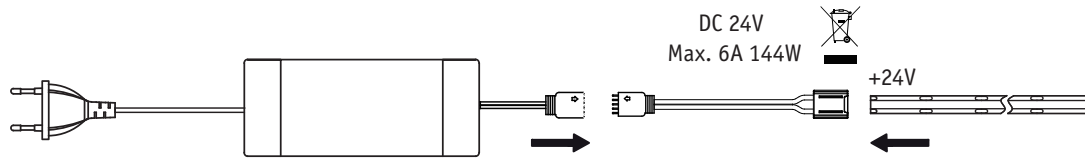
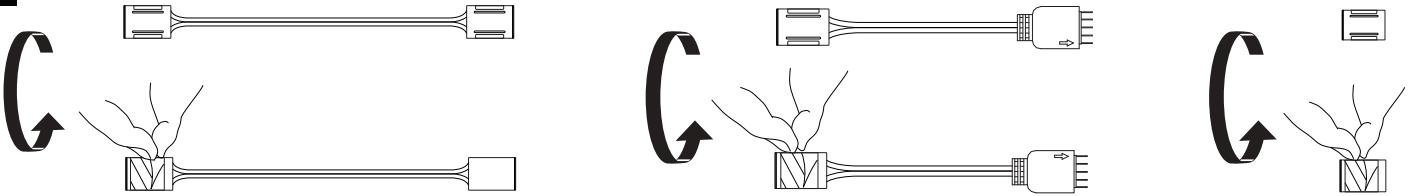
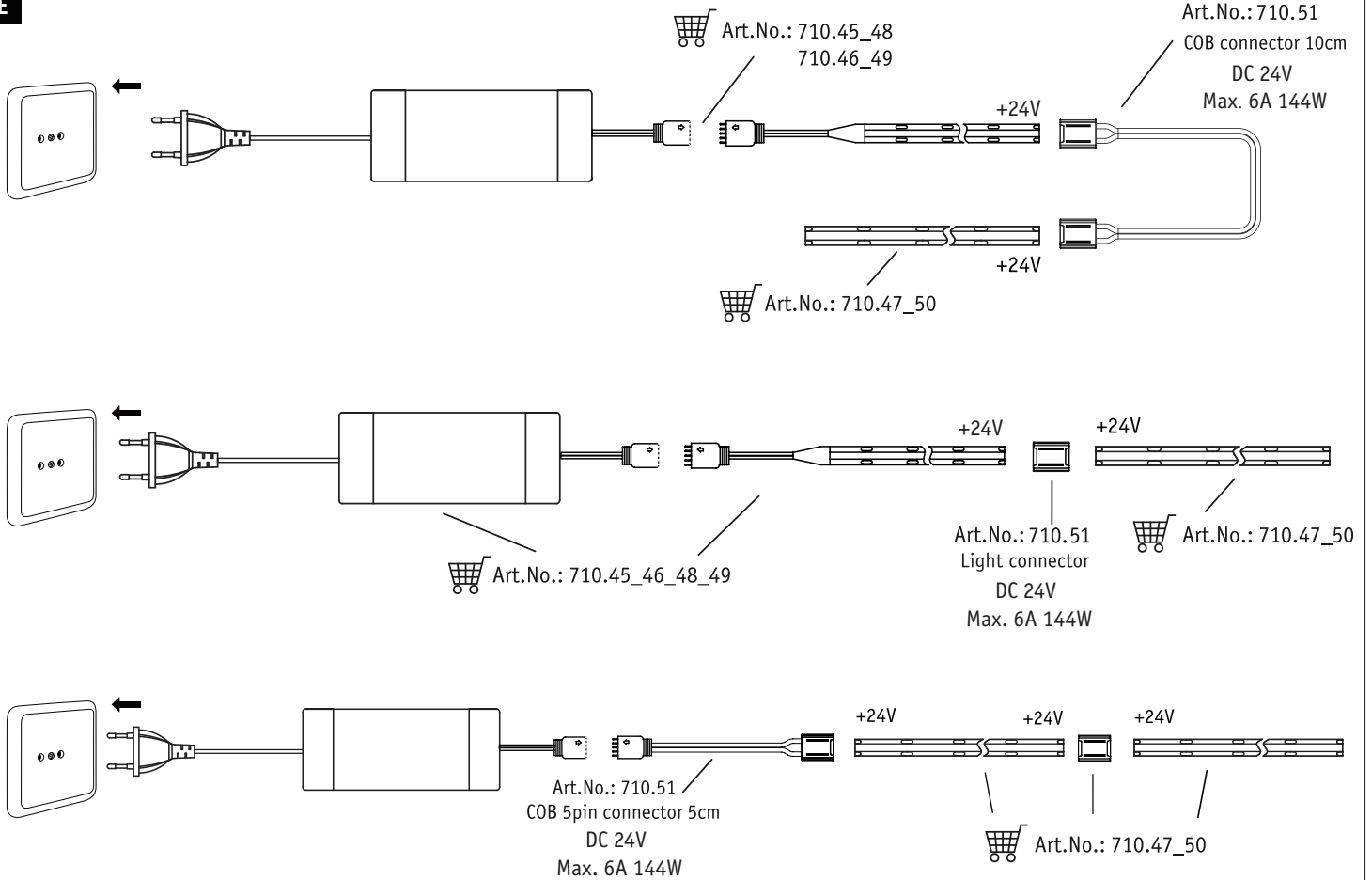

C**D****E**

= D Altgeräte dürfen nicht in den Restmüll. Sie können bei öffentlichen Sammelstellen von Entsorgungsträgern abgegeben werden. Altbatterien und Altkumulatoren, sowie Lampen, die zerstörungsfrei aus dem Altgerät entnommen werden können, sind vor der Abgabe an eine Erfassungs-

stelle von dem Altgerät zu trennen. Vertreiber sind im Rahmen von § 17 Absatz 1 und 2 ElektroG zur unentgeltlichen Rücknahme dieses Produktes verpflichtet. Endnutzer von Altgeräten müssen eigenverantwortlich für die Löschung personenbezogener Daten auf den zu entsorgenden Altgeräten sorgen.