

SCHALTBILDER

EZF 50/8 B

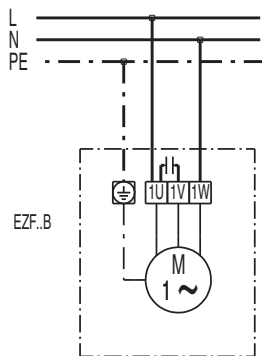
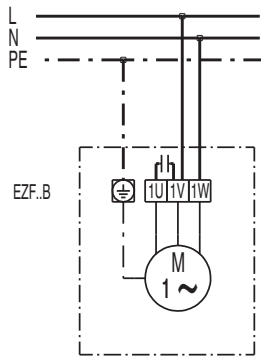

SCHALTBILDER

EZF 50/8 B

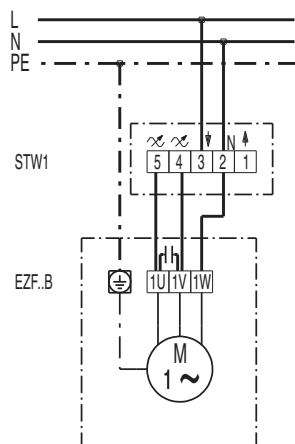
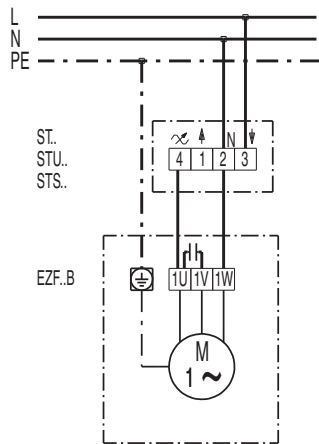

EZF 50/8 B

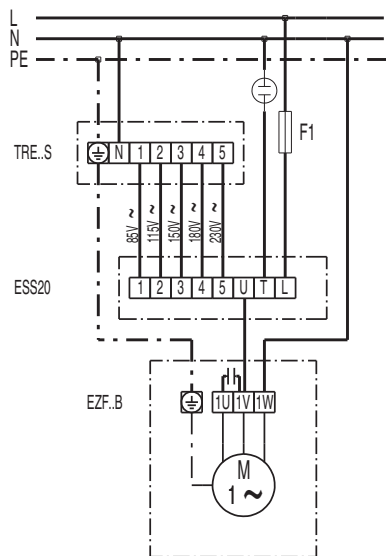
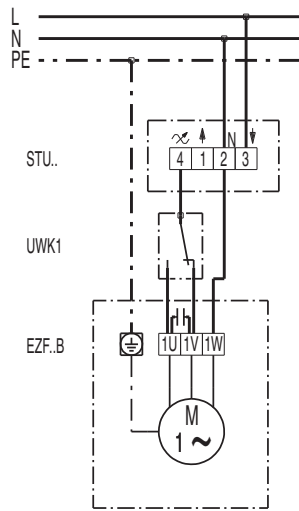

SCHALTBILDER

EZF 50/8 B

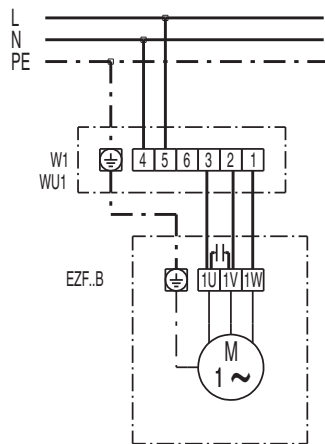
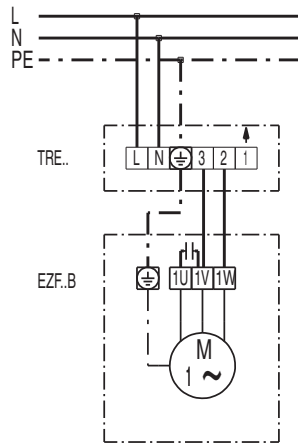

SCHALTBILDER

EZF 50/8 B

