

3:10

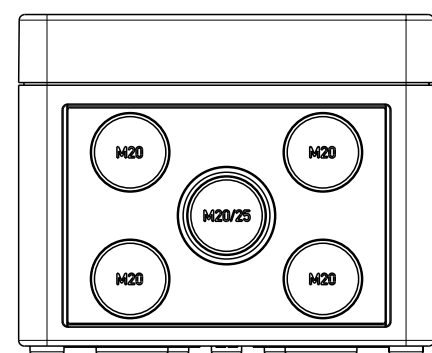

A-A

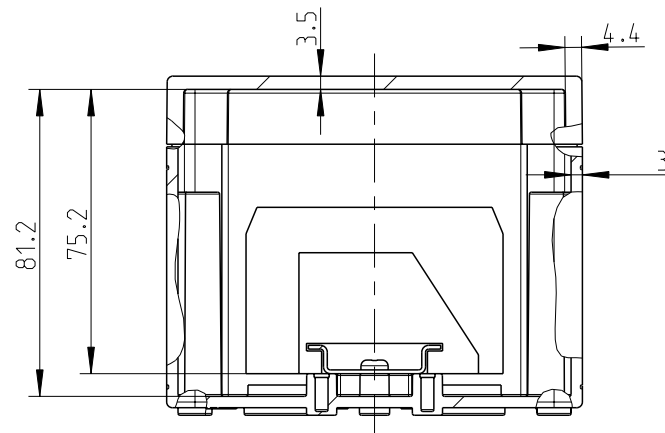

Ansicht ohne Deckel  
view without cover

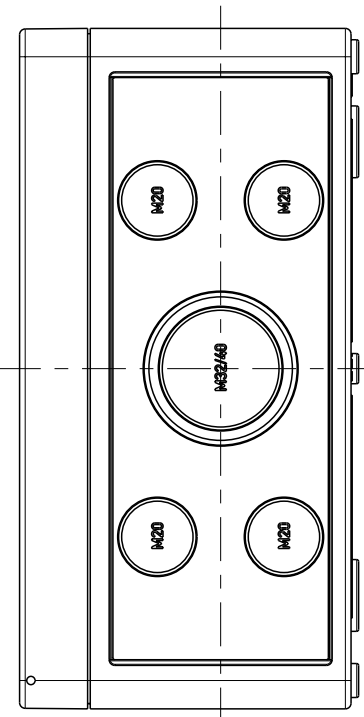
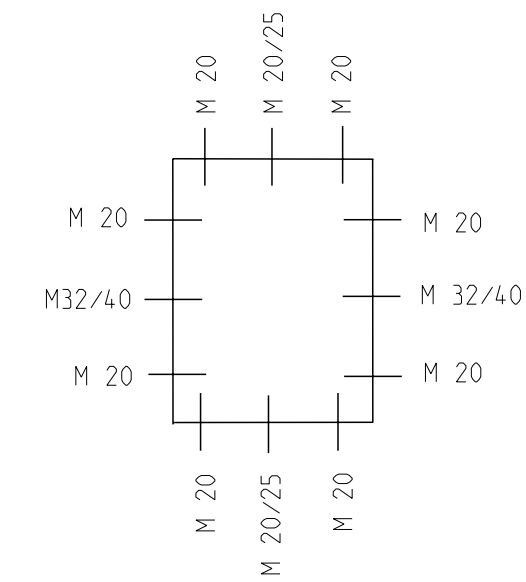
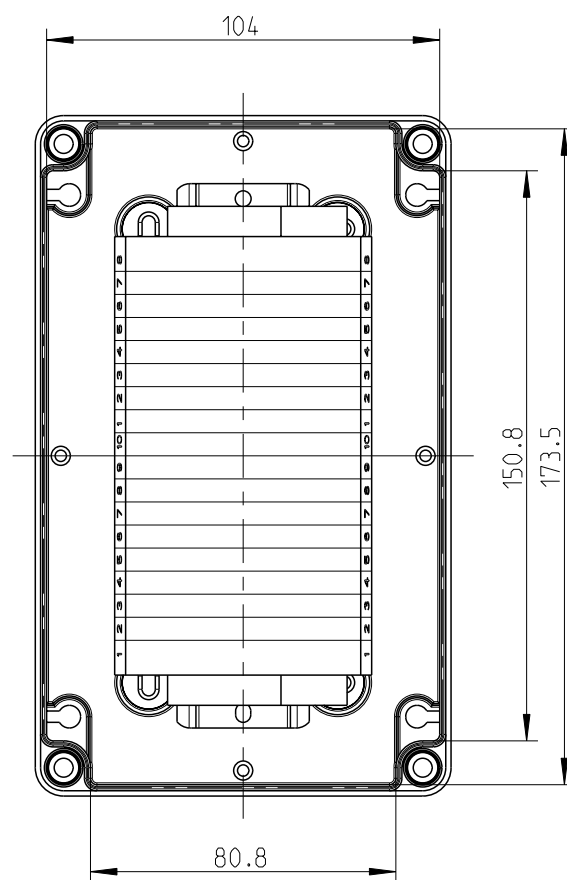

3:10

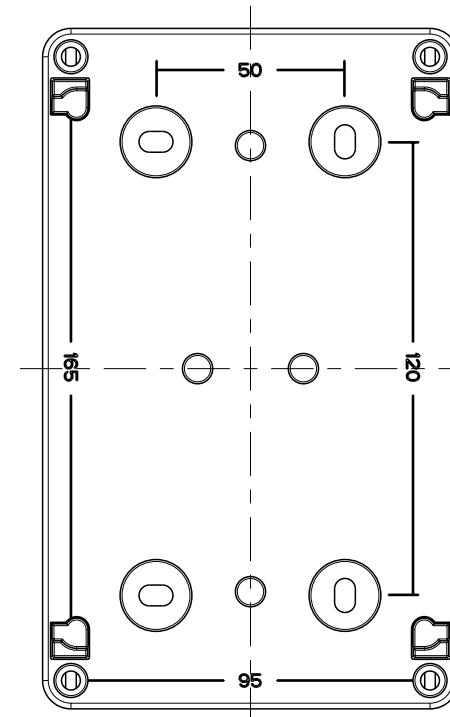
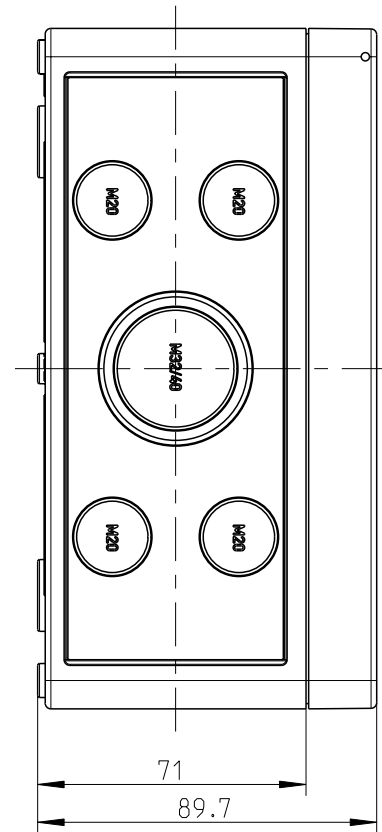
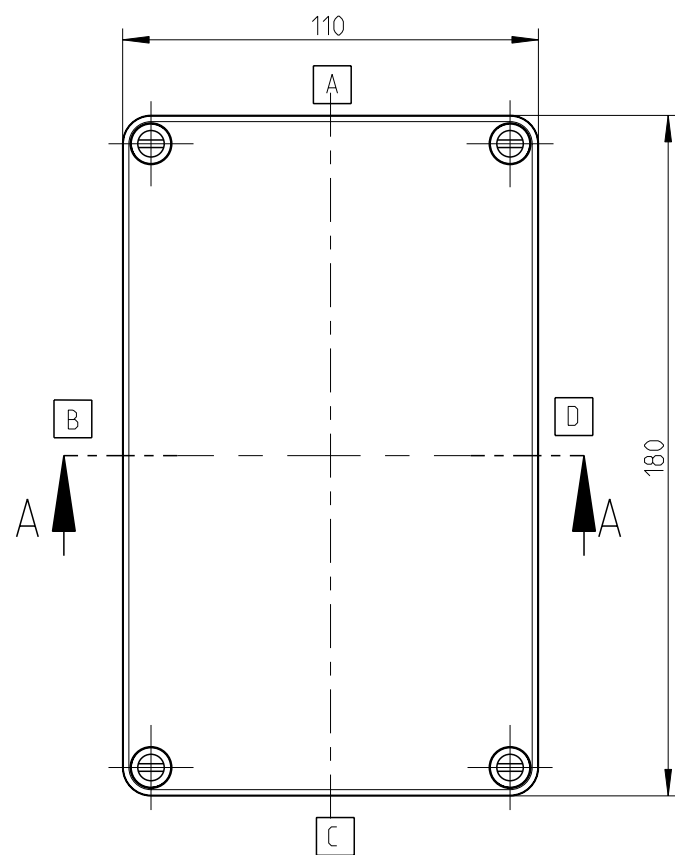

Fehlende Maße können dem Massblatt M-TK-1811 entnommen werden  
missing size can be taken from the dimensional sheet M-TK-1811

Schutzvermerk ISO 16016 beachten. Refer to protection notice ISO 16016. Maßstab: 1:2

**Massblatt**  
 RK 4/18 KSL-18x4<sup>2</sup>  
 M- RK 4/18 KSL-18x4<sup>2</sup>

0 Freigabe 07.01.16  
©Garenne Model: M-810-08-01 ©Garenne Zeichnung: M-810-08-01