

TR 6,6-2

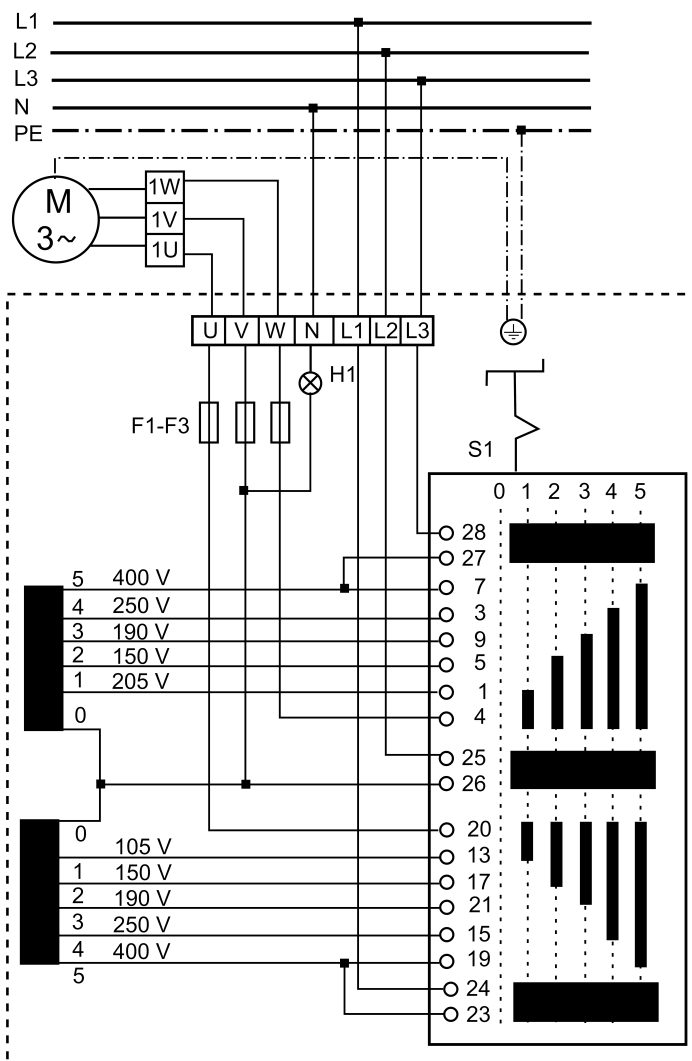

H1 - Betrieb (grün)
 S1 - Schalter: Ein/Aus
 M1 - Ventilatormotor (Drehstrom)