

Thermal Overload Relay J7TKN

Thermal Overload Relay

- Direct and separate mounting
- Single phasing sensivity according to IEC 60947-4-1
- Finger proof (BGV A2)

Accessories

- Set for single mounting

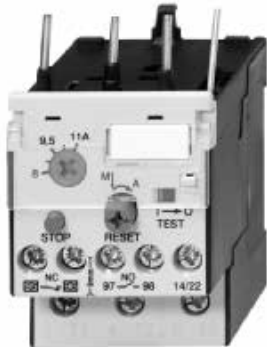

Approved Standards

Standard	Guide No (US,C)
UL	NKCR, NKCR7
IEC 60947-4-1	
VDE 0660	
EN 60947-4-1	

Ordering Information

Model Number Legend

1. Thermal Overload Relay

J7TKN-□-□□□
1 2 3

- 1) Thermal Overload Relay
- 2)
 - A: for mini motor contactor, manual reset
 - AA: for mini motor contactor (auto reset)
 - AB: for motor contactor (4-11 kW; manual reset)
 - B: for motor contactor (4-15 kW; manual and auto reset)
 - C: for motor contactor (18.5 kW)
 - D: for motor contactor (22-37 kW)
 - E: for motor contactor (45-55 kW)
 - F: for motor contactor (75-90 kW)
 - G: for motor contactor (110-160 kW)
 - H: for motor contactor (250-500 kW)
- 3) Setting range

E18: 0.12-0.18 A	24: 17-24 A
E27: 0.18-0.27 A	32: 23-32 A
E4: 0.27-0.4 A	42: 28-42 A
E6: 0.4-0.6 A	52: 40-52 A
E9: 0.6-0.9 A	65: 52-65 A
1E2: 0.8-1.2 A	74: 60-74 A
1E8: 1.2-1.8 A	90: 60-90 A
2E7: 1.8-2.7 A	120: 80-120 A
4: 2.7-4 A	180: 120-180 A
6: 4-6 A	216: 144-216 A
9: 6-9 A	320: 216-320 A
11: 8-11 A	360: 240-360 A
14: 10-14 A	540: 360-540 A
18: 13-18 A	800: 540-800 A



2. Accessories for Thermal Overload Relay



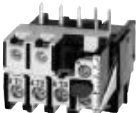
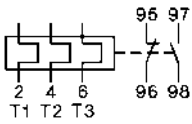
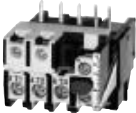
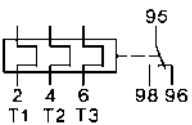

J74TK-□□
1 2

- 1) Accessories for Thermal Overload Relay
- 2)
 - SM: Single mounting for J7TKN-B Types (4-32 kW)
 - M-AB: Single Mounting for J7TKN-AB Types (4-11 kW)
 - SU-550: Busbar set for J7TKN-H (250-300 kW)
 - SU-860: Busbar set for J7TKN-H (400-500 kW)

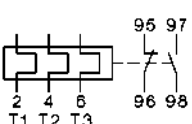

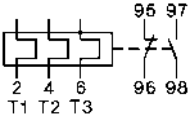

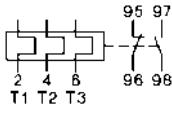

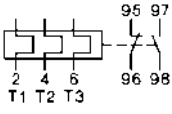
■ System overview

Thermal Overload Relays for plug-in mounting

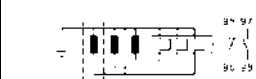
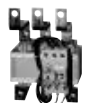

	Setting Range		Star Delta (A)	Type	Pack pcs.	Weight kg/pc.	
	D.O.L. (A)	(A)					
For contactors J7KNA-09..., J7KNA-12... Manual reset							
	0.12 - 0.18	-	-	 manual reset	J7TKN-A-E18	1	0.10
	0.18 - 0.27	-	-		J7TKN-A-E27	1	0.10
	0.27 - 0.4	-	-		J7TKN-A-E4	1	0.10
	0.4 - 0.6	-	-		J7TKN-A-E6	1	0.10
	0.6 - 0.9	-	-		J7TKN-A-E9	1	0.10
	0.8 - 1.2	-	-		J7TKN-A-1E2	1	0.10
	1.2 - 1.8	-	-		J7TKN-A-1E8	1	0.10
	1.8 - 2.7	-	-		J7TKN-A-2E7	1	0.10
	2.7 - 4	-	-		J7TKN-A-4	1	0.10
	4 - 6	7 - 10.5	-		J7TKN-A-6	1	0.10
	6 - 9	10.5 - 15.5	-		J7TKN-A-9	1	0.10
	8 - 11	14 - 19	-		J7TKN-A-11	1	0.10
10 - 14	18 - 24	-	J7TKN-A-14	1	0.10		
For contactors J7KNA-09..., J7KNA-12... Auto reset							
	0.12 - 0.18	-	-	 auto reset	J7TKN-AA-E18	1	0.10
	0.18 - 0.27	-	-		J7TKN-AA-E27	1	0.10
	0.27 - 0.4	-	-		J7TKN-AA-E4	1	0.10
	0.4 - 0.6	-	-		J7TKN-AA-E6	1	0.10
	0.6 - 0.9	-	-		J7TKN-AA-E9	1	0.10
	0.8 - 1.2	-	-		J7TKN-AA-1E2	1	0.10
	1.2 - 1.8	-	-		J7TKN-AA-1E8	1	0.10
	1.8 - 2.7	-	-		J7TKN-AA-2E7	1	0.10
	2.7 - 4	-	-		J7TKN-AA-4	1	0.10
	4 - 6	7 - 10.5	-		J7TKN-AA-6	1	0.10
	6 - 9	10.5 - 15.5	-		J7TKN-AA-9	1	0.10
	8 - 11	14 - 19	-		J7TKN-AA-11	1	0.10
10 - 14	18 - 24	-	J7TKN-AA-14	1	0.10		
For contactors J7KN(G)-10(D) to J7KN(G)-22(D) or single mounting Auto reset							
	0.12 - 0.18	-	-	 auto reset	J7TKN-AB-E18	1	0.10
	0.18 - 0.27	-	-		J7TKN-AB-E27	1	0.10
	0.27 - 0.4	-	-		J7TKN-AB-E4	1	0.10
	0.4 - 0.6	-	-		J7TKN-AB-E6	1	0.10
	0.6 - 0.9	-	-		J7TKN-AB-E9	1	0.10
	0.8 - 1.2	-	-		J7TKN-AB-1E2	1	0.10
	1.2 - 1.8	-	-		J7TKN-AB-1E8	1	0.10
	1.8 - 2.7	-	-		J7TKN-AB-2E7	1	0.10
	2.7 - 4	-	-		J7TKN-AB-4	1	0.10
	4 - 6	7 - 10.5	-		J7TKN-AB-6	1	0.10
	6 - 9	10.5 - 15.5	-		J7TKN-AB-9	1	0.10
	8 - 11	14 - 19	-		J7TKN-AB-11	1	0.10
10 - 14	18 - 24	-	J7TKN-AB-14	1	0.10		
13 - 18	23 - 31	-	J7TKN-AB-18	1	0.10		
17 - 23	30 - 40	-	J7TKN-AB-23	1	0.10		
22 - 30	38 - 52	-	J7TKN-AB-30	1	0.13		

	Setting Range			Type	Pack pcs.	Weight kg/pc.
	D.O.L. (A)	Star Delta (A)				
For contactors J7KN-10D... to J7KN-22...						
	0.12 - 0.18	-	 manual and auto reset	J7TKN-B-E18	1	0.14
	0.18 - 0.27	-		J7TKN-B-E27	1	0.14
	0.27 - 0.4	-		J7TKN-B-E4	1	0.14
	0.4 - 0.6	-		J7TKN-B-E6	1	0.14
	0.6 - 0.9	-		J7TKN-B-E9	1	0.14
	0.8 - 1.2	-		J7TKN-B-1E2	1	0.14
	1.2 - 1.8	-		J7TKN-B-1E8	1	0.14
	1.8 - 2.7	-		J7TKN-B-2E7	1	0.14
	2.7 - 4	-		J7TKN-B-4	1	0.14
	4 - 6	7 - 10.5		J7TKN-B-6	1	0.14
	6 - 9	10.5 - 15.5		J7TKN-B-9	1	0.14
	8 - 11	14 - 19		J7TKN-B-11	1	0.14
	10 - 14	18 - 24		J7TKN-B-14	1	0.14
	13 - 18	23 - 31		J7TKN-B-18	1	0.14
17 - 24	30 - 41	J7TKN-B-24	1	0.14		
23 - 32	40 - 55	J7TKN-B-32	1	0.14		
For contactors J7KN-24... to J7KN-40...						
	22 - 42	48 - 73	 manual and auto reset	J7TKN-C-42	1	0.30
For contactors J7KN-50...-J7KN-74...						
	40 - 52	70 - 90	 manual and auto reset	J7TKN-D-52	1	0.40
	52 - 65	90 - 112		J7TKN-D-65	1	0.40
	60 - 74	104 - 128		J7TKN-D-74	1	0.40

Thermal Overload relays for separate mounting

Setting Range		Star Delta (A)		Type	Pack	Weight
D.O.L.	(A)		(A)		pcs.	kg/pc.
For contactors J7KN-90... to J7KN-115...						
	60 - 90	104 - 156		J7TKN-E-90	1	0.90
	80 - 120	140 - 207		J7TKN-E-120	1	0.90
For contactors J7KN-151... to J7KN-176... (incl. busbar set)						
	120 - 180	208 - 312		J7TKN-F-180	1	1.5
For contactors J7KN-210... to J7KN-316... (incl. busbar set)						
	144 - 216	250 - 374		J7TKN-G-216	1	1.8
	216 - 320	374 - 554		J7TKN-G-320	1	1.8
For contactors J7KN-450... to J7KN-860... (excl. busbar set)						
	240 - 360	416 - 623		J7TKN-H-360	1	4.2
	360 - 540	623 - 935		J7TKN-H-540	1	4.2
	540 - 800	935 - 1385		J7TKN-H-800	1	4.2

Accessories

	for overload relay	Cable Cross-section to clamp (mm ²)			Type	Pack	Weight
		solid or stranded	flexible	flex. with multicore cable end		pcs.	kg/pc.
Sets for single mounting							
	J7TKN-AB	0.75 - 6	0.75 - 4	0.5 - 4	J74TK-M-AB	1	0.035
	J7TKN-B	0.75 - 6	0.75 - 4	0.5 - 4	J74TK-SM	1	0.035
					Type	Pack	Weight
for overload relay		for contactors				Set	Set
Busbar sets							
	J7TKN-H-360/540	J7KN-450, J7KN-550			J74TK-SU-550	1	1.7
	J7TKN-H-540/800	J7KN-700, J7KN-860			J74TK-SU-860	1	2.1

Specifications

Engineering data and Characteristics

Thermal Overload Relays, tripping times for selection to motors of protection degree EEx e
Relays With Standard Tripping Characteristic

Setting Range		Tripping time(in seconds) depending on the multiple of the current setting from cold condition (tolerance $\pm 20\%$ of the tripping time)					
A	A	I_A/I_N 3	I_A/I_N 4	I_A/I_N 5	I_A/I_N 6	I_A/I_N 7,2	I_A/I_N 8
J7TKN-A*...							
0,12	- 0,18	18,5	10,4	7,2	5,5	4,3	3,6
0,18	- 0,27	16,7	9,8	6,5	5	4,1	3,5
0,27	- 0,4	19,4	12,1	8,2	5,9	4,9	4,2
0,4	- 0,6	18,7	11,2	8	6	4,9	4,1
0,6	- 0,9	19,7	11,6	8,1	6,1	4,9	4,2
0,8	- 1,2	22,9	13,6	10	7,3	6	5,2
1,2	- 1,8	22,2	13,2	9,2	7,6	5,8	5,3
1,8	- 2,7	23	13,7	9,3	7,6	5,7	5,1
2,7	- 4	24	14,4	9,9	7,8	5,9	5,1
4	- 6	24,7	13,8	9,9	7,3	5,6	4,8
6	- 9	22	13,4	8	5,7	4,1	3,5
8	- 11	17,4	9,2	5,9	4,1	2,9	2,3
10	- 14	26,4	12,9	7,6	5,2	3,5	2,8
13	- 18	4,7	7,7	4,8	3,2	2,3	1,7
17	- 23	16,2	8,4	5,0	3,6	2,4	1,8
22	- 30	16,8	8,5	5,0	3,6	2,3	1,9
J7TKN-B...							
0,12	- 0,18	16,1	9,6	6,8	5,3	4,2	3,7
0,18	- 0,27	16,6	9,7	6,7	5,2	4,1	3,6
0,27	- 0,4	19,4	11,4	7,9	6,1	4,7	4,2
0,4	- 0,6	18,7	10,9	7,6	5,9	4,6	4,0
0,6	- 0,9	19,2	11,2	7,7	5,9	4,6	4,1
0,8	- 1,2	20,8	12,3	8,5	6,6	5,2	4,6
1,2	- 1,8	25,5	14,1	9,8	7,6	5,9	5,2
1,8	- 2,7	26,6	15,6	10,9	8,3	6,5	5,7
2,7	- 4	22,7	13,6	9,5	7,4	5,8	5,1
4	- 6	22,2	13,3	9,3	7,1	5,6	4,9
6	- 9	20,4	11,9	8,2	6,1	4,7	4,0
8	- 11	20,9	11,8	7,9	5,7	4,3	3,5
10	- 14	21,3	11,7	7,4	5,1	3,7	3,0
13	- 18	21,2	12,1	8,0	6,2	4,6	4,1
17	- 24	20,4	12	8,6	6,3	4,5	3,7
23	- 32	20,2	10,2	6,7	4,7	3,4	2,8
J7TKN-C-42							
28	- 42	25,2	13,3	8	5,5	4	3,1
J7TKN-D...							
40	- 52	18,3	9,2	5,6	3,9	2,8	2,2
52	- 65	17,8	8,7	5,2	3,4	2,5	1,9
60	- 74	19,5	13,5	11	10	9,5	8,5
J7TKN-E...							
60	- 90	19,5	13,5	11	10	9,5	8,5
80	- 120	18	11	10	9	8,5	8
J7TKN-H...							
260	- 360	23,3	14,1	10,0	7,6	6,1	5,4
340	- 480	23,0	13,8	9,6	7,6	6,1	5,4
440	- 620	20,5	12,4	9,0	7,0	5,5	5,0
560	- 800	21,0	12,5	9,0	7,0	6,6	5,2

When selecting a standard overload, refer to the tripping curve. Determine the values of the starting current ratio I_A/I_N and the time t_E which is marked on the label of the motor. The overload must trip within the t_E time, which means that the tripping curve from cold condition must be (20% due to tolerance) below the coordination point I_A/I_N and the time t_E .

I_A = Starting current of motor

I_N = Rated current of motor

t_E = t_E -time of motor

All tripping times of overload relays J7TKN-A* are shorter than the minimum values of the t_E time for motors of protection degree EEx e acc. to EN 50019 and therefore are suitable for all motors of protection degree EEx e. For these overload relays the selection on basis of tripping curves is thereby not necessary.

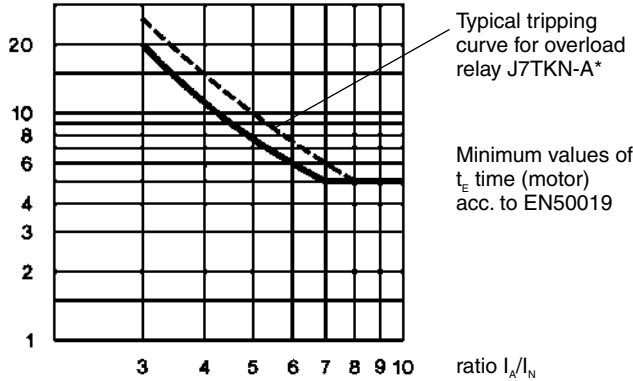

Labels of tripping curves for each setting range, sized 148x105mm (self-adhesive) are available on request.

Specify type and setting range.

Fuses for J7TKN-A; J7TKN-B; J7TKN-C; J7TKN-D; J7TKN-E; J7TKN-F/G/H

Type	Setting Range						Max. Fuse Size According to Coordination-type				Fuse UL	Fuse UL (SCCR) Short Circuit Current Rating kA
	DOL			Star Delta			"2" ¹ quick	slow, gL(gG)	"1" ¹ slow, gL(gG)	aM		
	A		A	A		A	A	A	A			
J7TKN-A*	0.12	-	0.18		-		0.5 ²	0.5 ²	25	-	15	5
J7TKN-B	0.18	-	0.27		-		1.0 ²	1.0 ²	25	-	15	5
	0.27	-	0.4		-		2	2	25	-	15	5
	0.4	-	0.6		-		2	2	25	-	15	5
	0.6	-	0.9		-		4	4	25	-	15	5
	0.8	-	1.2		-		4	4	25	2	15	5
	1.2	-	1.8		-		6	6	25	2	15	5
	1.8	-	2.7		-		10	10	25	4	15	5
	2.7	-	4		-		16	10	25	4	15	5
	4	-	6	7	-	10.5	20	16	25	6	15	5
	6	-	9	10.5	-	15.5	35	25	35	10	25	5
	8	-	11	14	-	19	35	25	35	16	30	5
	10	-	14	18	-	24	50	35	63	16	40	5
	13	-	18	23	-	31	50	35	63	20	50	5
	17	-	24	30	-	41	63	50	63	25	60	5
	23	-	32	40	-	55	80	63	80	35	70	5
J7TKN-C	28	-	42	48	-	73	100	80	150	50	110	5
J7TKN-D	40	-	52	70	-	90	160	100	150	63	200	5
	52	-	65	90	-	112	160	125	150	80	250	10
	60	-	74	104	-	128	160	125	150	80	250	10
J7TKN-E	60	-	90	104	-	156	For short circuit protecting overload relays with current transformer use fuse according to the contactor of the combination.				300	10
	80	-	120	140	-	207					-	-
J7TKN-F/G/H	all ranges										-	-

*1) Coordination-type according to IEC 60947-4-1:

„2“: Light contact welding accepted. Thermal overload relay must not be damaged.

„1“: Welding of contactor and damage of the thermal overload relay allowed.

*2) Miniature fuse

Tripping Characteristics for J7TKN-A*, J7TKN-B, J7TKN-C, J7TKN-D

Detailed tripping times for each range see table page 5

with three-phase load

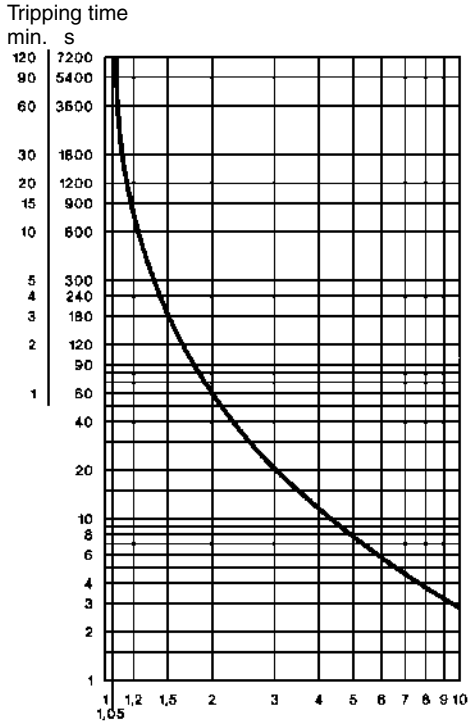

Average value of typical tolerance curves from cold condition

Proceeding from service conditions the times decrease to 20-30% of the characteristic values

F.L.C. multiplication factor

with two-pole load

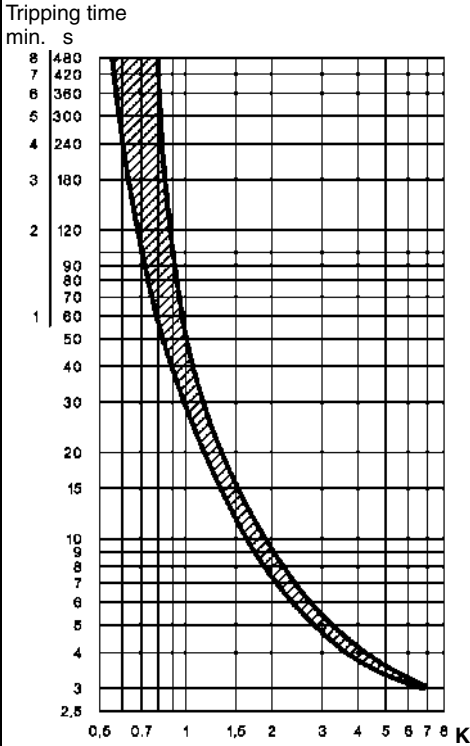

Typical tolerance curve from cold condition

Proceeding from service conditions the times decrease to 70-80% of the characteristic values

$K = I_{max}/I_e$

I_{max} = max. phase current
 I_e = max. scale value

Tripping Characteristics for J7TKN-E

Detailed tripping times for each range see table page 5

with three-phase load

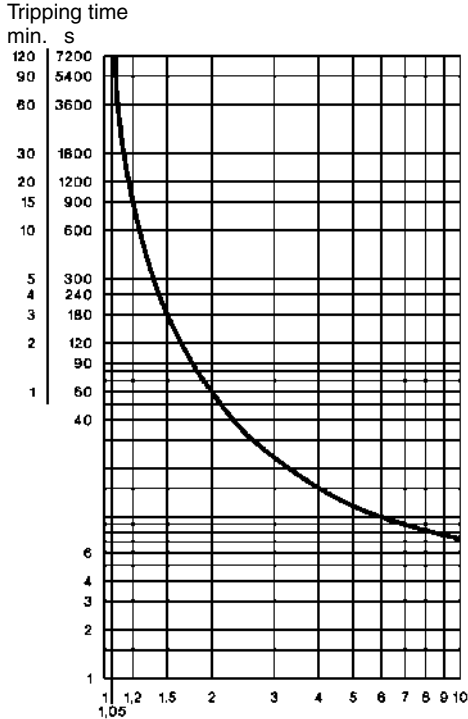

Average value of typical tolerance curves from cold condition

Proceeding from service conditions the times decrease to 20-30% of the characteristic values

F.L.C. multiplication factor

with two-pole load

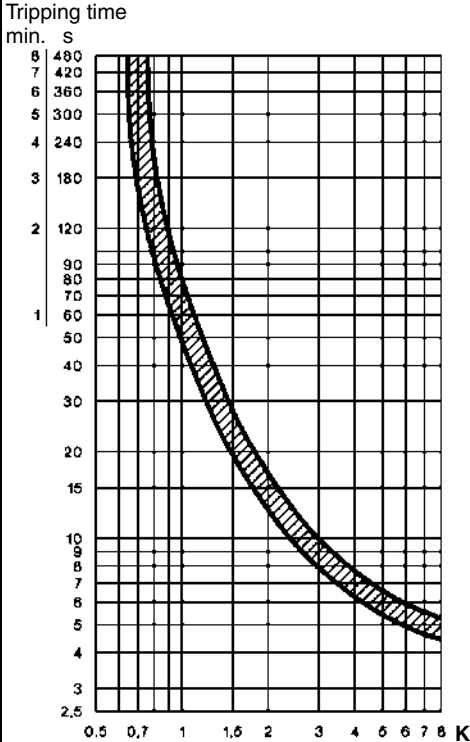

Typical tolerance curve from cold condition

Proceeding from service conditions the times decrease to 70-80% of the characteristic values

$K = I_{max}/I_e$

I_{max} = max. phase current
 I_e = max. scale value

Tripping Characteristics for J7TKN-F, J7TKN-G

Detailed tripping times for each range see table page 5

with three-phase load

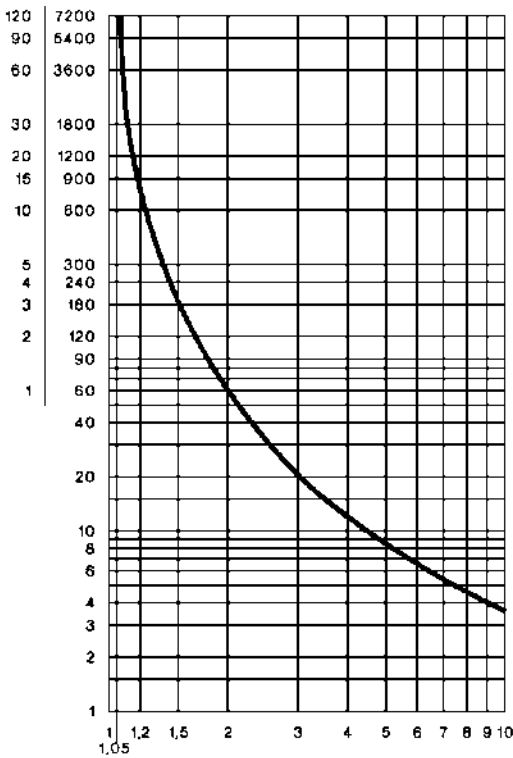

Tripping Characteristics for J7TKN-H

Detailed tripping times for each range see table page 5

with three-phase load

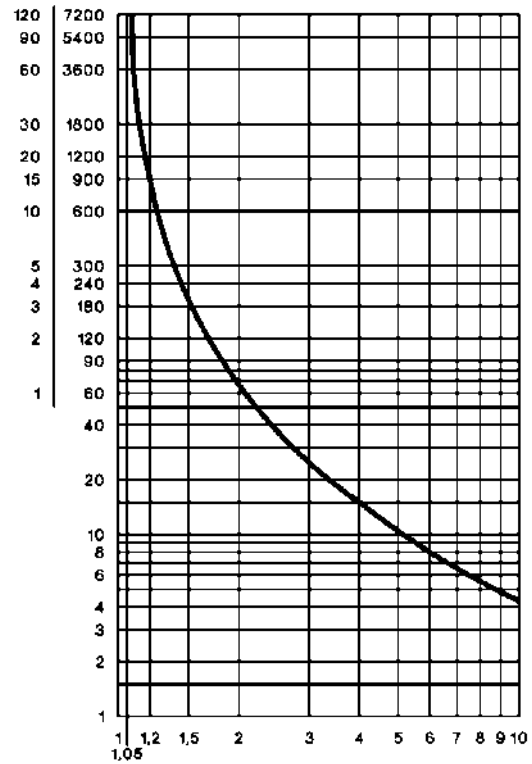

Position of Terminals

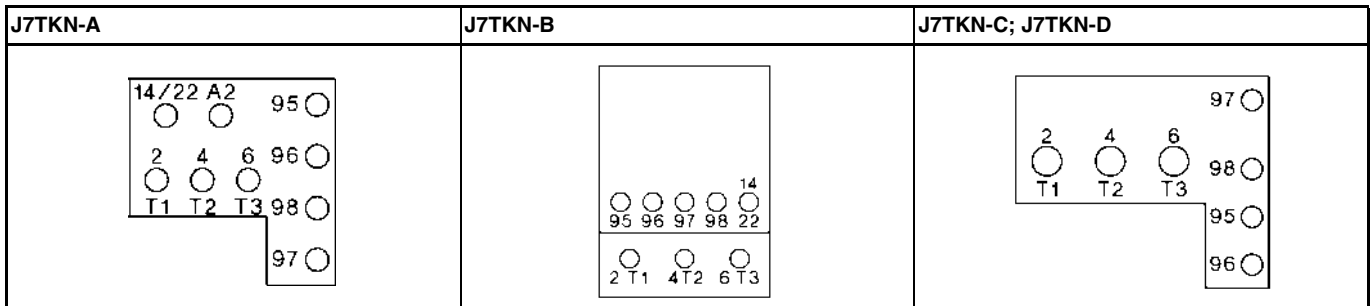

Thermal Overload Relays

Data according to IEC 60947-4-1, IEC 60947-5-1, VDE 0660, EN 60947-4-1, EN 60947-5-1

			J7TKN-A(B)	J7TKN-AA	J7TKN-B	J7TKN-C	J7TKN-D	J7TKN-E	J7TKN-F	J7TKN-G	J7TKN-H
Type											
Rated insulation voltage U_i^{*1}	V~		690	690	690	690	690	750	1000	1000	1000
Permissible ambient temperature											
operation	open	°C					-25 to 60				-25 to 55
storage		°C					-50 to 70				-40 to 70
Trip class according to IEC 60947-4-1			10A	10A	10A	10A	10A	20	10A	10A	10
Cable cross-section											
main connector	solid or stranded	mm ²	0.75-6 + 0.75-2.5 ^{*2}	0.75-6 + 0.75-2.5 ^{*3}	0.75-6	0,75-10	4-35 ^{*2}	^{*4}	Busbar	Busbar	^{*5}
		mm ²	0.75-4 + 0.5-2.5 ^{*2}	0.75-4 + 0.5-2.5 ^{*2}	1-4	0,75-6	6-25 ^{*2}		18x4	25x6	
	flexible with multicore cable end	mm ²	0.5-2.5 + 0.5-1.5	0.5-2.5 + 0.5-1.5	0.75-4	0.75-6	4-25		Screw M8	Screw M10	
Cables per clamp	number		1+1	1+1	2	2	1		1	1	
auxiliary connector	solid	mm ²					0.75-2.5 ^{*2}				1-2.5 ^{*2}
		mm ²					0.5-2.5 ^{*2}				1-2.5 ^{*2}
		mm ²					0.5-1.5				1-2.5 ^{*2}
Cables per clamp	number						2				2
Auxiliary contacts											
Rated insulation voltage U_i^{*1}											
same potential	V~		690	690	690	690	690	690	690	690	500
different potential	V~		440	440	440	250	250	440	440	440	500
Utilization category AC15											
Rated operational current I_e	24V	A	5	5	3	4 ^{*6}	4 ^{*6}	5	3	3	4 ^{*7}
	230V	A	3	3	2	2.5	2.5	3	2	2	2.5
	400V	A	2	2	1	1.5	1.5	2	1	1	1.5
	690V	A	0.6	0.6	0.5	0.6	0.6	0.6	0.5	0.5	0.6
Utilization category DC13											
Rated operational current I_e	24V	A	1.2	1.2	1	1.2	1.2	1.2	1.2	1.2	1.2
	110V	A	0.15	0.15	0.15	0.15	0.15	0.15	0.15	0.15	0.15
	220V	A	0.1	0.1	0.1	0.1	0.1	0.1	0.1	0.1	0.1
Short circuit protection (without welding 1kA)											
highest fuse rating	gL (gG)	A	6	6	4	6	6	6	4	4	6
Setting range	A		to 23	to 23	all	28-42	52-65	all	-	-	-
Power loss per current path (max.)											
minimum setting value	W		1.1	1.1	1.1	1.3	2.9	1.1	-	-	-
maximum setting value	W		2.3	2.3	2.3	3.3	4.5	2.5	-	-	-

*1) Suitable for: earthed-neutral systems, overvoltage category I to III, pollution degree 3 (standard-industry: $U_{imp} = 4kV$ (at 440V), 6kV (at 690V). Data for other conditions on request.

*2) Maximum cable cross-section with prepared conductor

*3) Maximum cable cross-section with prepared conductor

*4) Without terminals, suitable for bushing one connector 70mm² (stranded) per phase

*5) Busbar sets see accessories page 4

*6) Switching capacity of the start contact: AC15 300VA, max. 1.5A, DC13 (max. 220V) 30W, max. 1.5A

*7) Switching capacity of the make contact: AC15 400VA, max. 1.7A, DC13 (max. 220V) 10W, max. 1A

Data according to cULus

Type		J7TKN-A	J7TKN-B	J7TKN-C	J7TKN-D	J7TKN-E
Rated insulation voltage	V~	600	600	600	600	600
Rated current	A	23	32	42	74	85
Auxiliary contacts						
Rated voltage						
same potential	V AC	600	600	600	600	600
different potential	V~	150	150	150	150	150
Switching capacity AC						
of aux. contacts	VA	500	500	600	600	600
	A	4	2	4	4	4

Temperature Compensation

In case of higher ambient temperature use the following formula:
 (Ambient temperature - 20) × 0.125 = correction factor in % of the full load motor current

Example:
 Ambient temperature 70°C, full load motor current 7A
 (70 - 20) × 0.125 = 6.25%
 Setting value: 7A + 6,25% = 7.44A

■ Dimensions

J7KNA-09 + J7TKN-A(A)
 J7KNA-12

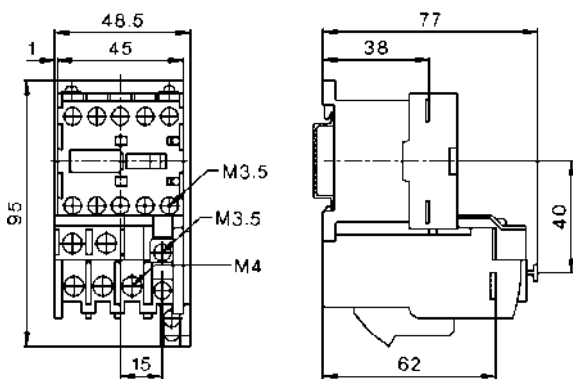

J7KN-10D + J7TKN-AB
 J7KN-14D
 J7KN-18D
 J7KN-22D

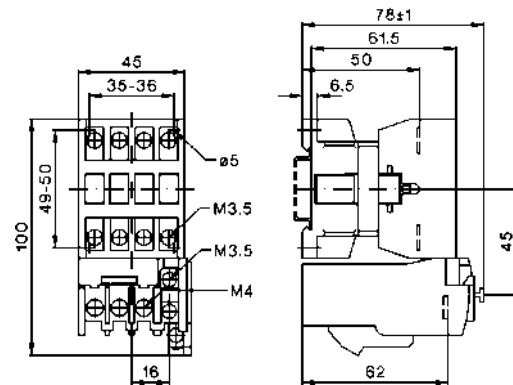

J7KNG-10 + J7TKN-AB
 J7KNG-14
 J7KNG-18
 J7KNG-22

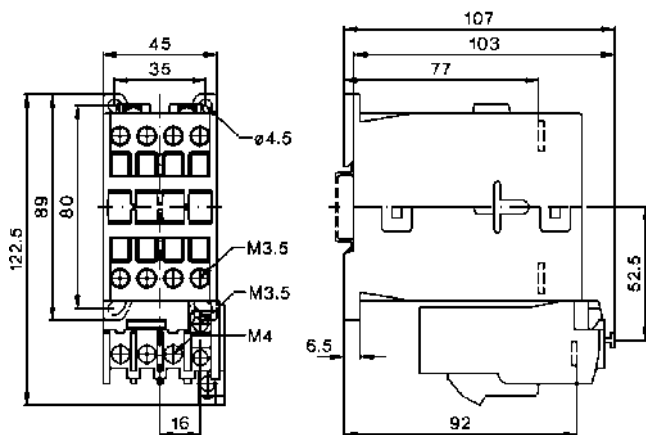

J7KN-10D + J7TKN-B
 J7KN-14D
 J7KN-18D
 J7KN-22D

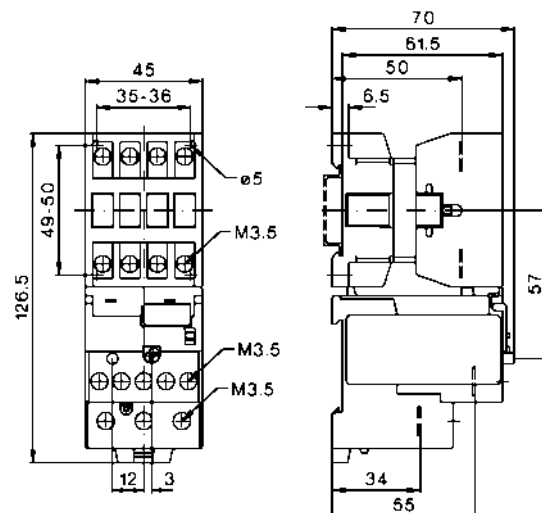

J7KNG-10 + J7TKN-B
J7KNG-14
J7KNG-18
J7KNG-22

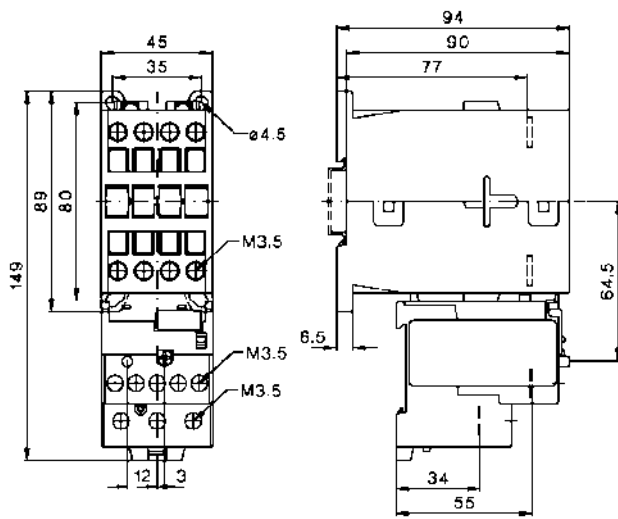

J7KN-24 + J7TKN-B
J7KN-32
J7KN-40

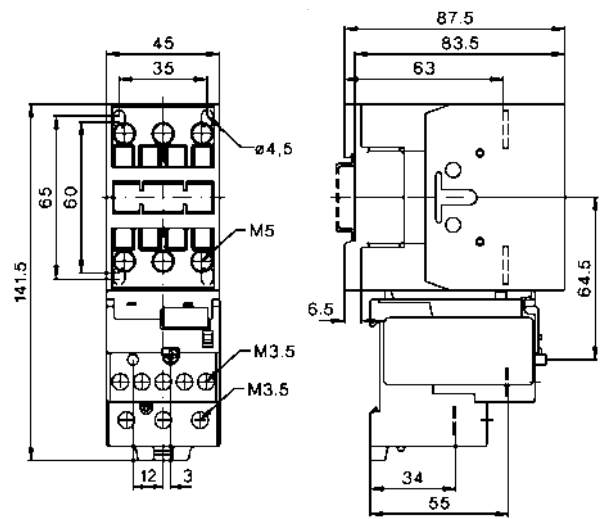

J7KNG-24 + J7TKN-B
J7KNG-32

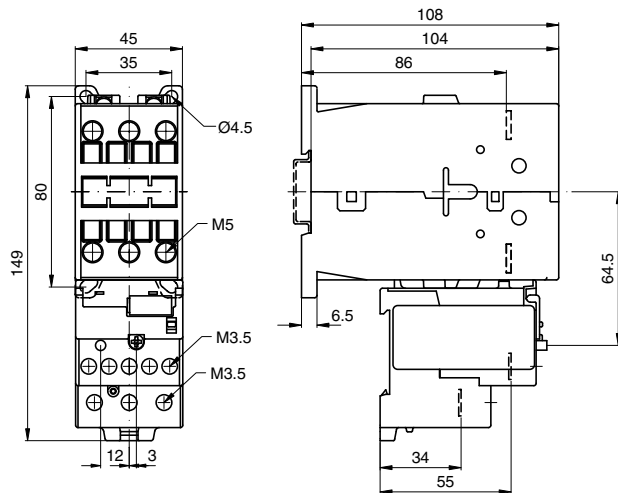

J7KN-24 + J7TKN-C
J7KN-32
J7KN-40

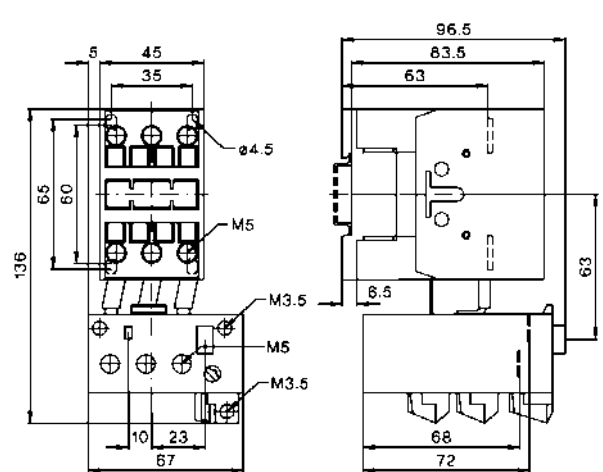

J7KNG-40 + J7TKN-C

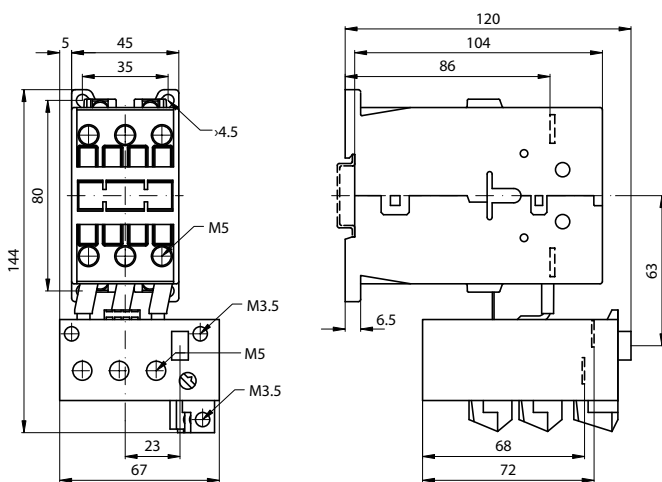

J7KN-50 + J7TKN-D
J7KN-62
J7KN-74

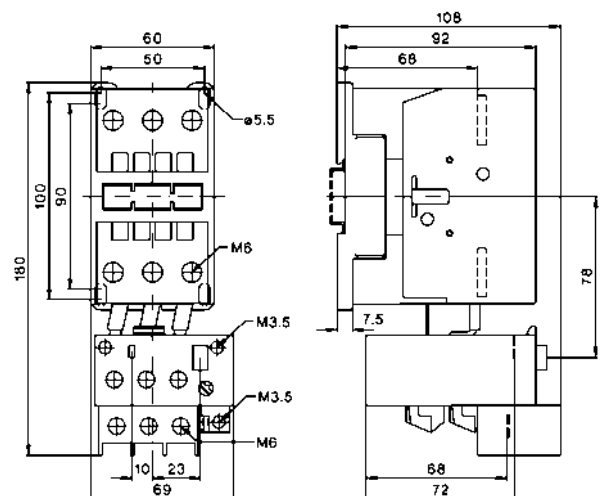

J7KN-90 + J7TKN-E
J7KN-115

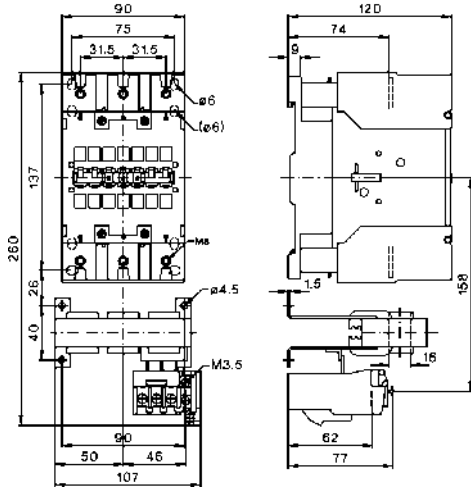

J7KN-151 + J7TKN-F
J7KN-176

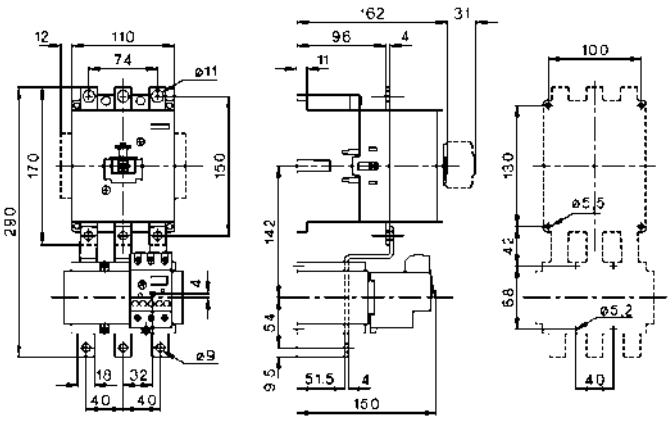

J7KN-210 + J7TKN-G
J7KN-260
J7KN-316

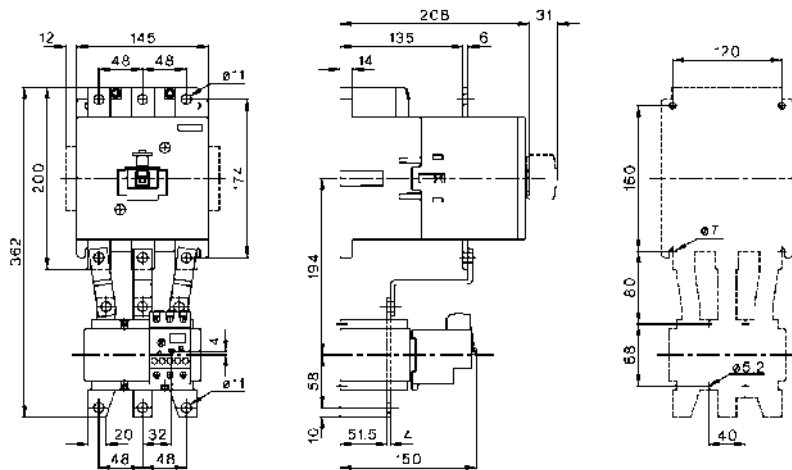

J7TKN-H with
J7KN-450
J7KN-550
J7KN-700
J7KN-860

	A	B	C	D	E	F	G	H	J	K
J7KN-450	220	372	110	220	158	40	185	225	12,5	9
J7KN-550	220	395	110	220	158	40	185	225	12,5	9
J7KN-700	280	487	175	280	202	50	257	291	14,5	11
J7KN-860	280	540	175	280	202	50	257	291	14,5	11

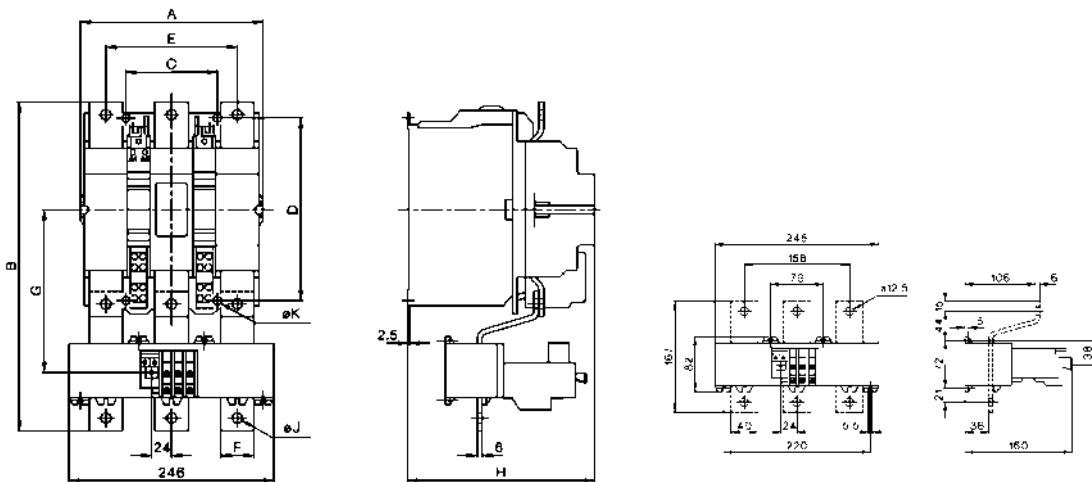

J74TK-M-AB

J7TKN-AB + J74TK-M-AB for snap-on 35 mm DIN-rail according to DIN EN50022 and screw mounting (single mounting)

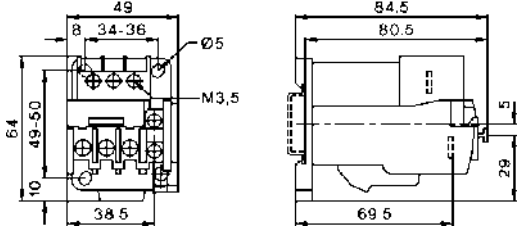

Do not use/install these products before having read the applicable precautions as listed in Cat. No. J09-EN-01 available from www.europe.omron.com or on request from OMRON local sales office.

ALL DIMENSIONS SHOWN ARE IN MILLIMETERS.