

SCHALTBILDER

DZR 35/42 B

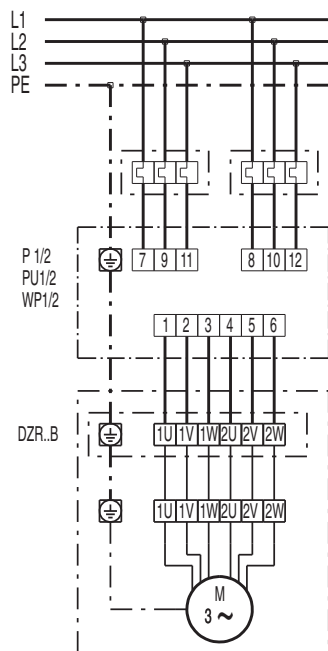

SCHALTBILDER

DZR 35/42 B

