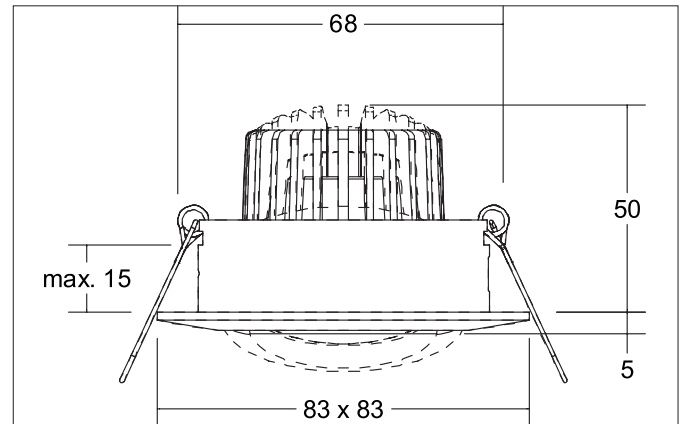

BRENA-S LED recessed spot set, trailing-edge phase dimmable

Article no. 39142023

Light.
For Generations.**Tender**

LED recessed spot set, trailing-edge phase dimmable, Square. Toolless ceiling installation by installation springs. Ceiling cut-out Ø 68 mm, Installation depth 50 mm, Outer diameter 88 mm, Weight 0,323 kg, Reflector silver with rotationssymmetrical, deep, wide distributed light intensity. optimal light distribution due to a glass transparent cover. Luminous flux 680 lm, Power 1 x 6 W, System Efficiency 113 lm/W, Light colour warm white, Correlated color temperature (CCT) 3.000 K, Colour rendering index CRI > 80, Housing material: Aluminium / Glass, Permissible ambient temperature (ta): -20 °C - +25 °C, Protection class (EN 61140): II, Degree of protection (DIN EN 60529): IP20. With electronic driver, Trailing-edge phase dimmable.

Article data	
Article no.	39142023
GTIN	4251433950783
Series name	BRENA-S
Short description	LED recessed spot set, trailing-edge phase dimmable
Material	Aluminium / Glass
Type of surface	Glossy
Shape	Round
Outer diameter	88 mm
Built-in diameter	68 mm
Installation depth	50 mm
Length	83 mm
Width	83 mm
Height	5 mm
Weight	0.323 kg

BREENA-S LED recessed spot set, trailing-edge phase dimmable

Article no. 39142023

Light.
For Generations.

Lighting technology	
Colour temperature	3.000 K
Light colour	White
Light output	Direct
Luminous flux	680 lm
System efficiency	113 lm/W
Colour rendering	CRI > 80
Reflector	High-gloss
Reflektorfarbe	silver
Beam angle	38°
Light sharing	Symmetric

Operating technology of the luminaire	
Lamp holder	Plug&Play
Power	6 W
Voltage type	DC
Current	350 mA
Lamp	LED
Protection class	III
Degree of protection	IP20

Operating technology of driver	
Length	110 mm
Width	50 mm
Hight	19 mm
AC nominal voltage min	198 V
AC nominal voltage max	264 V
Frequenz max.	50 Hz
Dimmable	Yes
Control	Trailing-edge phase
Starting current	1A (15,2 µs)
Power min	2.8 W
Power	7 W
Current	350 mA
Degree of protection	IP20
Protection class	II
Flickerfrei	Yes

Mounting technology	
Mounting method	Recessed mounting
Place of installation	Ceiling-mounted
Adjustability	Pivoted
Swivel angle	20°
Max. ceiling thickness	15 mm
Further references	No cover with thermal insulation material
Material cover	Glass transparent
Circlip	Without circlip
Suitable for through-wiring	Yes, with optional accessories

BREENA-S LED recessed spot set, trailing-edge phase dimmable

Article no. 39142023

Light.
For Generations.

Packing data	
Gross weight	0.38 kg
Length of packaging	100 mm
Packaging width	100 mm
Packaging height	100 mm
Disposal at end of life	<p>This product must not be disposed of with household waste. You are obliged, to dispose of such electrical waste separately.</p> <p>By disposing of electrical waste and other old or defective electronics separately, you support recycling or other forms of re-use. In that way you help to take care and to avoid that harmful substances get into the environment.</p>