

CAR EVO M ACCESSORY

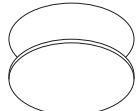

60800843
 CAR EVO M
 FOIL VFL

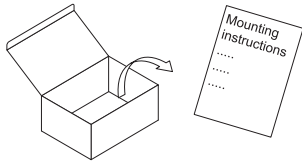
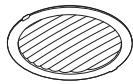

60800853
 CAR EVO M
 OVAL OUTLINE LENS

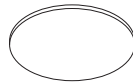

60800844
 CAR EVO M
 PROTECTION GLASS

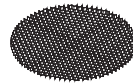

60800852
 CAR EVO M
 HONEYCOMB
 LOUVRE BK

$$\boxed{1} - \boxed{2} + \boxed{5}$$

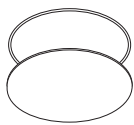

60800845
 CAR EVO M
 SOFT OUTLINE LENS

$$\boxed{1} - \boxed{3} + \boxed{5}$$

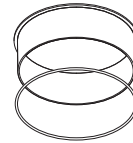

60800842
 CAR EVO M
 TUBE BK

$$\boxed{1} + \boxed{4} - \boxed{5}$$

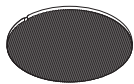

60800857 CAR EVO M
 BOPT

$$\boxed{1} + \boxed{6} - \boxed{8}$$



60800849 CAR EVO M
 VOPT

$$\boxed{1} + \boxed{7} + \boxed{9}$$



60800846 CAR EVO M
 REFL SP

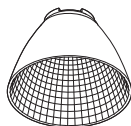

60800847 CAR EVO M
 REFL FL

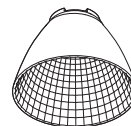

60800848 CAR EVO M
 REFL WFL

$$\boxed{1} + \boxed{10} - \boxed{12}$$



EN Important notices. Please, read first! 1

DE Wichtige Hinweise. Bitte zuerst lesen! 2

FR Remarques importantes. À lire en premier lieu ! 2

IT Note importanti. Si prega di leggere prima! 2

NL Belangrijke informatie. Gelieve eerst te lezen! 2

NO/SV Viktigt information. Läs först! 2

FI Terkeä huomautus. Lue ensin! 2

ES Notas importantes. Por favor, lea primero! 2

RU Важная информация. Просьба ознакомиться перед началом работ! 3

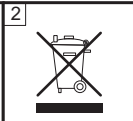
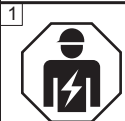

1 The installation and commissioning of the luminaire as well as any modification to the luminaire may only be performed by authorized personnel (qualified electrician).

The manufacturer is not liable for damages resulting from improper or faulty installation or operation or from unauthorized modifications to the luminaire.



Caution, risk of electric shock! Disconnect mains cables and any existing DALI control lines from mains and check that the power is off before conducting any maintenance and assembly work.





















Hot plug-in is not permitted. Hot plug-in may result in damage to the luminaire and entail loss of warranty claims!



2 Dispose of packaging and luminaire in accordance with applicable regional regulations.

Keep the instructions safe!

Specifications are subject to change without notice! If you have questions, please contact the manufacturer.

| | | |
|--|--|--|
| 1 | 2 | |
|    | <p>1 Die Montage und Inbetriebnahme der Leuchte sowie jede Veränderung an der Leuchte darf nur von autorisierten Fachkräften (qualifizierter Elektriker) durchgeführt werden. Der Hersteller haftet nicht für Schäden, die aus fehlerhafter Montage, aus unsachgemäßem Betrieb oder unautorisierten Veränderungen an der Leuchte resultieren. Vorsicht, Gefahr eines elektrischen Schlages. Vor Wartungs- und Montagearbeiten, Netzleitungen und vorhandene DALI Steuerleitungen freischalten und auf Spannungsfreiheit überprüfen. Hot Plug-In ist verboten. Hot Plug-In kann zu Schäden an der Leuchte und zum Verlust der Garantie führen!</p> <p>2 Verpackung und Leuchte umweltgerecht nach geltenden regionalen Vorschriften entsorgen. Anleitung aufbewahren! Technische Änderungen vorbehalten! Bei Fragen wenden sie sich an den Hersteller.</p> | |
|    | <p>1 L'installation et la mise en service du luminaire ainsi que toute modification au luminaire doivent être effectuées par un personnel autorisé (électricien qualifié). Le fabricant décline toute responsabilité pour des dommages résultant d'une erreur de montage, d'une exploitation non conforme ou de modifications non autorisées effectuées sur le luminaire. Avertissement, risque de choc électrique. Prudence. Avant tous travaux de montage et d'entretien, déconnectez les câbles d'alimentation et les lignes de commande DALI et assurez-vous de leur mise hors tension. Le raccordement en cours de service (hot plug-in) est interdit. Il peut provoquer l'endommagement du luminaire et la perte de la garantie!</p> <p>2 Éliminez l'emballage et le luminaire dans le respect de l'environnement et des prescriptions régionales. Conservez cette notice! Modifications techniques sans préavis! Si vous avez des questions, veuillez contacter le fabricant.</p> | |
|    | <p>1 L'installazione e la messa in servizio degli apparecchi, nonché qualsiasi modifica dell'apparecchio può essere eseguita solo da personale autorizzato (elettricista qualificato). Il produttore non risponde di danni derivanti da montaggio erraneo, utilizzo improprio o modifiche non autorizzate sull'apparecchio. L'apparecchio è destinato esclusivamente all'illuminazione e va installato in conformità alle leggi nazionali in vigore. Attenzione, pericolo di scarica elettrica. Prima di ogni intervento di montaggio o manutenzione staccare i cavi di rete e gli eventuali cavi DALI verificando che la tensione sia assente. Hot Plug-In è vietato. L'Hot Plug-In può danneggiare l'apparecchio e comportare la perdita della garanzia!</p> <p>2 Imballaggio e apparecchio vanno smaltiti in conformità alle leggi nazionali in vigore. Conservare le istruzioni! Modifiche tecniche senza preavviso! Per chiarimenti rivolgersi al produttore.</p> | |
|    | <p>1 De montage en inbedrijfstelling van de armatuur en eventuele wijzigingen aan de armatuur mogen uitsluitend door geautoriseerde vaklui (gekwalificeerde elektriciens) worden uitgevoerd. De fabrikant is niet aansprakelijk voor schade die voortvloeit uit een foutieve montage, een niet correct gebruik of niet geautoriseerde wijzigingen aan de armatuur. Opgelet! Gevaar voor een elektrische schok. Voorafgaand aan onderhouds- en montagewerken moeten de net- en eventuele DALI-stuurleidingen van het net ontkoppeld en op spanningsvrijheid gecontroleerd worden. 'Hot plug-in' is verboden. Dit kan leiden tot schade aan de armatuur en verlies van de garantie.</p> <p>2 De verpakking en de armatuur moeten conform de geldende regionale milieuvoorschriften uit de economische kringloop verwijderd worden. Houd deze gebruiksaanwijzingen zorgvuldig bij! Technische wijzigingen blijven voorbehouden! Als u vragen hebt, kan u contact opnemen met de fabrikant.</p> | |
|     | <p>1 Installation och drifttagning av armaturen samt all annan modifiering av armaturen får endast utföras av kvalificerad personal (behörig elektriker). Tillverkaren ansvarar inte för skador som uppkommer på grund av felaktig installation, felaktig användning eller obehöriga modifieringar på armaturen. Var försiktig – risk för elektriska stötar. Koppla från elnät och eventuellt befintliga DALI-styrledningar och kontrollera att de är spänningsfria före underhålls- och installationsarbeten. Hot plugin är förbjudet. Hot plugin kan skada armaturen och leda till att garantin upphör att gälla!</p> <p>2 Avfallshantera förpackning och armatur enligt gällande lokala föreskrifter. Spara anvisningen! Med reservation för tekniska ändringar! Om du har frågor ber vi dig ta kontakt med tillverkaren. Idrifttagning efter byggfasen, när nätspänningen är tillgänglig kontinuerligt!</p> | |
|    | <p>1 Vain valtuutettu ammattihenkilö (koulutettu sähkömies) saa suorittaa valaisimen asennuksen ja käyttöäönnoton tai muutoksia valaisimessa. Valmistaja ei vastaa vahingoista, joiden syynä ovat valaisimen epäasianmukainen käyttö tai omavaltaiset muutokset. Varo sähköiskun vaaraa! Kytke verkkojohdot ja mahdolliset DALI-ohjausjohdot irti ja varmista, että niissä ei ole virtaa ennen huolto- tai asennustöiden aloittamista. Älä kytke laitetta käynnissä olevaan järjestelmään. Se voi vaurioittaa valaisinta ja aiheuttaa takuun raukeamisen.</p> <p>2 Hävitä pakkaus ja valaisin ympäristöä suojellen ja voimassa olevien paikallisten määräysten mukaisesti. Säilytä käyttöopas! Oikeudet teknisiin muutoksiin pidätetään! Lähetä mahdolliset kysymykset valmistajalle.</p> | |
|    | <p>1 El montaje y la puesta en servicio de la luminaria así como toda modificación de la luminaria deberán ser realizados exclusivamente por personal técnico autorizado (electricista certificado). El fabricante no se responsabiliza por los daños derivados del montaje incorrecto u operación indebida de la luminaria así como de las modificaciones no autorizadas en la luminaria. Precaución: peligro de descarga eléctrica. Antes de proceder a labores de mantenimiento y montaje, desconecte de la red los cables de alimentación así como todo cable de control DALI y verifique la ausencia de tensión. No está permitida la conexión en caliente. ¡La conexión en caliente puede dañar la luminaria e invalidar la garantía! 2 Deseche el embalaje y la luminaria de forma ecológica conforme a las normas regionales aplicables. ¡Guarde las instrucciones! ¡Reservado el derecho de realizar modificaciones técnicas sin preaviso! Si tiene alguna pregunta, póngase en contacto con el fabricante.</p> | |

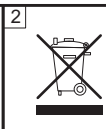
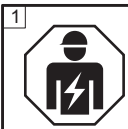

RU

1 **Монтаж и ввод в эксплуатацию**, а также любое изменение конструкции лампы может осуществляться только уполномоченными специалистами (квалифицированным электриком).

Производитель не несет - ответственности за повреждения, возникшие в результате неправильной сборки, ненадлежащей эксплуатации или несогласованного изменения конструкции лампы.

«Горячее» подключение плагинов не допускается. «Горячее» подключение плагинов может привести к повреждениям лампы и потере гарантии!

2 Утилизацию упаковки и лампы следует проводить в соответствии с действующими региональными правилами.

Сохраняйте инструкцию!

Компания сохраняет за собой право на внесение технических изменений.

При возникновении вопросов обращайтесь к производителю.

1

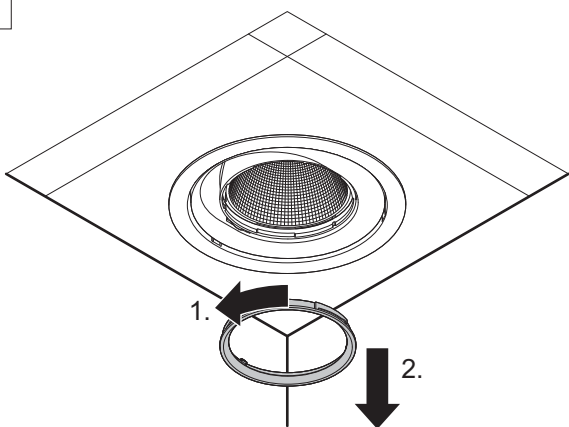

2

60800843

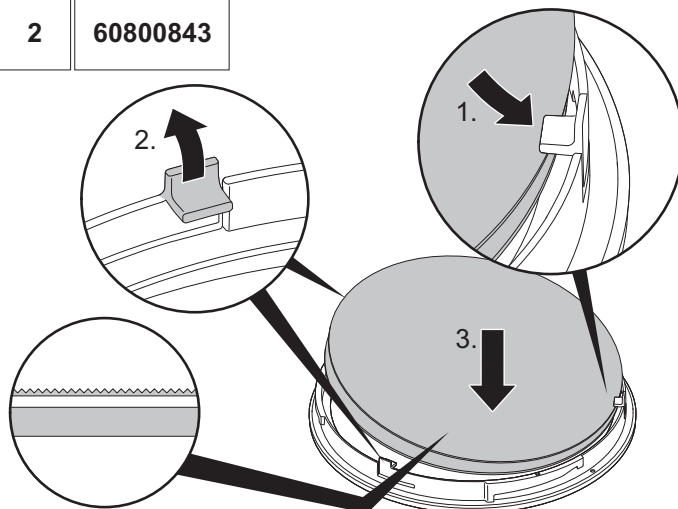

2

60800845

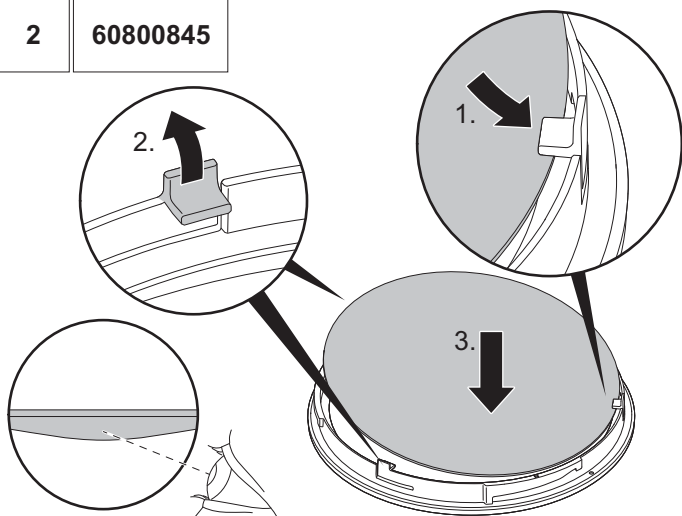

2

60800853

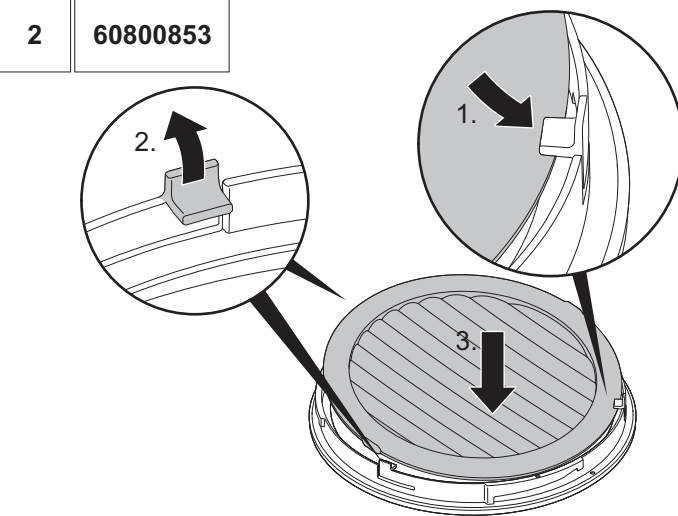

3

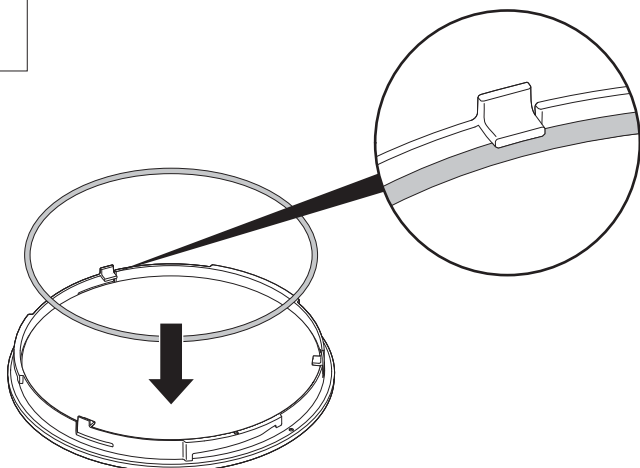

4

