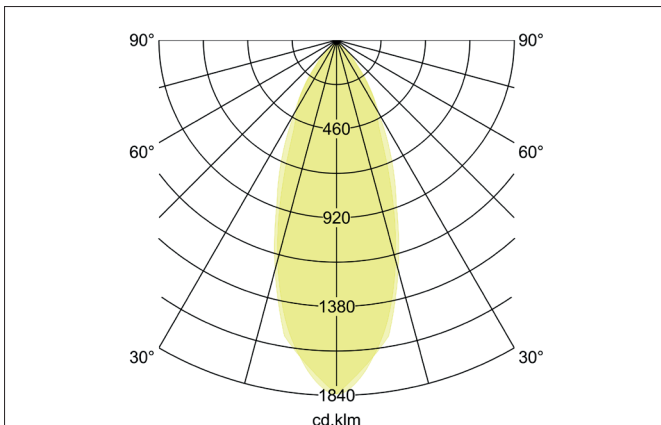
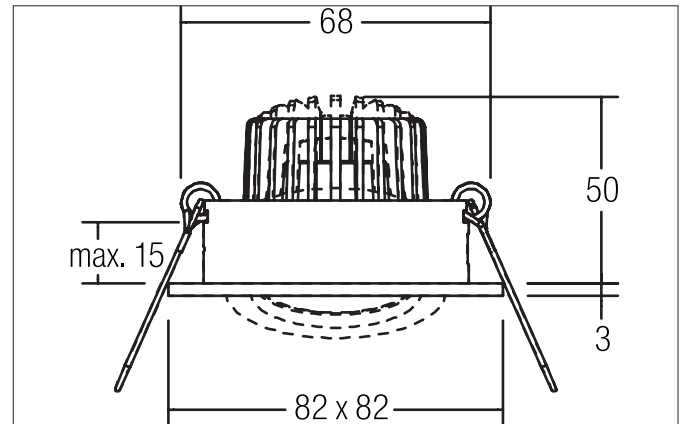

PAYTON-S LED recessed spot

Article no. 12376253

Light.
For Generations.**Tender**

LED recessed spot, Square. Toolless ceiling installation by installation springs. Ceiling cut-out \varnothing 68 mm, Installation depth 50 mm, Length 82 mm, Width 82 mm, Weight 0,150 kg, Reflector silver with rotationssymmetrical, deep, wide distributed light intensity. optimal light distribution due to a glass transparent cover. Luminous flux 310 lm, Power 1 x 3 W, System Efficiency 103 lm/W, Light colour warm white, Correlated color temperature (CCT) 3.000 K, Colour rendering index CRI > 80, Housing material: Aluminium / Glass, Colour: Alu, Permissible ambient temperature (t_a): -20 °C - +25 °C, Protection class (EN 61140): III, Degree of protection (DIN EN 60529): IP20. For connection to an external driver, which is not included in the scope of delivery of the luminaire. Depending on driver dimmable.

Product Benefits

- Square recessed spotlight made of solid aluminum with a glass cover.
- Easy and tool-free mounting.
- CRI > 80.
- Low installation depth 50 mm, length 82 mm, width 82 mm, Ceiling cut-out 68 mm.
- Ceiling thickness maximum 13 mm.
- Large article variance in terms of housing color and color temperature.
- Power supply with 350 mA.
- Alternatively available in round design.

PAYTON-S LED recessed spot

Article no. 12376253

Light.
For Generations.

| Article data | |
|--------------------|-------------------|
| Article no. | 12376253 |
| GTIN | 4251433946700 |
| Series name | PAYTON-S |
| Short description | LED recessed spot |
| Material | Aluminium / Glass |
| Colour | Alu |
| Type of surface | Matt |
| Shape | Square |
| Built-in diameter | 68 mm |
| Installation depth | 50 mm |
| Length | 82 mm |
| Width | 82 mm |
| Height | 3 mm |
| Weight | 0.150 kg |

| Lighting technology | |
|---------------------|------------|
| Colour temperature | 3.000 K |
| Light colour | White |
| Light output | Direct |
| Luminous flux | 310 lm |
| System efficiency | 103 lm/W |
| Colour rendering | CRI > 80 |
| Reflector | High-gloss |
| Reflektorfarbe | silver |
| Beam angle | 38° |
| Light sharing | Symmetric |

| Operating technology of the luminaire | |
|---------------------------------------|--|
| Voltage type | DC |
| Current | 350 mA |
| Lamp | LED |
| Lamp holder | Plug&Play |
| Protection class | III |
| Degree of protection | IP20 |
| Dimmable | Depending on type of control gear |
| Control | Depending on driver |
| Bulb change possible | The light source of this luminaire may only be replaced by the manufacturer or a service technician commissioned by him or a similarly qualified person. |

| Mounting technology | |
|------------------------|---|
| Mounting method | Recessed mounting |
| Place of installation | Ceiling-mounted |
| Adjustability | Pivoted |
| Swivel angle | 20° |
| Max. ceiling thickness | 13 mm |
| Further references | No cover with thermal insulation material |
| Material cover | Glass transparent |
| Circlip | Without circlip |

PAYTON-S LED recessed spot

Article no. 12376253











Light.
For Generations.

| Packing data | |
|-------------------------|--|
| Gross weight | 0.223 kg |
| Length of packaging | 100 mm |
| Packaging width | 100 mm |
| Packaging height | 100 mm |
| Disposal at end of life | <p>This product must not be disposed of with household waste. You are obliged, to dispose of such electrical waste separately.</p> <p>By disposing of electrical waste and other old or defective electronics separately, you support recycling or other forms of re-use. In that way you help to take care and to avoid that harmful substances get into the environment.</p> |

PAYTON-S LED recessed spot

Article no. 12376253

Light.
For Generations.

| Accessories | |
|---|---|
|  | Article no.: 17666000 LED converter 350 mA, on/off switchable Power: 1 - 5 W Dimensions: 52 mm x 30 mm x 23 mm |
|  | Article no.: 17662000 LED converter 350 mA, on/off switchable Power: 1 - 7,2 W Dimensions: 68 mm x 35 mm x 21 mm |
|  | Article no.: 17662010 LED converter 350 mA, on/off switchable Power: 1 - 7,2 W Dimensions: 68 mm x 35 mm x 21 mm |
|  | Article no.: 17662020 LED converter 350 mA, on/off switchable Power: 1 - 7,2 W Dimensions: 68 mm x 35 mm x 21 mm |
|  | Article no.: 17613000 LED converter 350 mA, on/off switchable Power: 1 - 15 W Dimensions: 115 mm x 34 mm x 19 mm |
|  | Article no.: 17613010 LED converter 350 mA, on/off switchable Power: 1 - 15 W Dimensions: 115 mm x 34 mm x 19 mm |
|  | Article no.: 17613020 LED converter 350 mA, on/off switchable Power: 1 - 15 W Dimensions: 115 mm x 34 mm x 19 mm |
|  | Article no.: 17621000 LED converter 350 mA, on/off switchable Power: 1 - 21 W Dimensions: 128 mm x 50 mm x 13 mm |
|  | Article no.: 17621010 LED converter 350 mA, on/off switchable Power: 1 - 21 W Dimensions: 128 mm x 50 mm x 13 mm |
|  | Article no.: 17621020 LED converter 350 mA, on/off switchable Power: 1 - 21 W Dimensions: 128 mm x 50 mm x 13 mm |

PAYTON-S LED recessed spot

Article no. 12376253



Light.
For Generations.

| Accessories | |
|---|--|
|  | Article no.: 17663000 LED converter 350 mA, trailing-edge phase dimmable Power: 2,8 - 7 W Dimensions: 110 mm x 50 mm x 19 mm |
|  | Article no.: 17663010 LED converter 350 mA, trailing-edge phase dimmable Power: 2,8 - 7 W Dimensions: 110 mm x 50 mm x 19 mm |
|  | Article no.: 17663020 LED converter 350 mA, trailing-edge phase dimmable Power: 2,8 - 7 W Dimensions: 110 mm x 50 mm x 19 mm |
|  | Article no.: 17648000 LED converter 350 mA, trailing-edge phase dimmable Power: 0,7 - 17 W Dimensions: 166 mm x 46 mm x 34 mm |
|  | Article no.: 17648010 LED converter 350 mA, trailing-edge phase dimmable Power: 0,7 - 17 W Dimensions: 166 mm x 46 mm x 34 mm |
|  | Article no.: 17648020 LED converter 350 mA, trailing-edge phase dimmable Power: 0,7 - 17 W Dimensions: 166 mm x 46 mm x 34 mm |
|  | Article no.: 17684000 LED converter 350 mA, DALI dimmable (digital) Power: 2,8 - 7 W Dimensions: 130 mm x 42 mm x 22 mm |
|  | Article no.: 17684010 LED converter 350 mA, DALI dimmable (digital) Power: 2,8 - 7 W Dimensions: 130 mm x 42 mm x 22 mm |
|  | Article no.: 17684020 LED converter 350 mA, DALI dimmable (digital) Power: 2,8 - 7 W Dimensions: 130 mm x 42 mm x 22 mm |
|  | Article no.: 17658000 LED round converter 350 mA, DALI dimmable (digital) Power: 2,1 - 9 W Dimensions: 56 mm x 25 mm |
|  | Article no.: 17658010 LED round converter 350 mA, DALI dimmable (digital) Power: 2,1 - 9 W Dimensions: 56 mm x 25 mm |

PAYTON-S LED recessed spot

Article no. 12376253

Light.
For Generations.

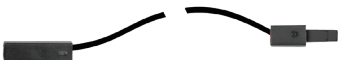
| Accessories | |
|---|---|
|  | <p>Article no.: 17658020 LED round converter 350 mA, DALI dimmable (digital) Power: 2,1 - 9 W Dimensions: 56 mm x 25 mm</p> |
|  | <p>Article no.: 3835 Plug & Play extension lead 350 mA Dimensions: 500 mm</p> |
|  | <p>Article no.: 3836 Plug & Play extension lead 350 mA Dimensions: 1,000 mm</p> |
|  | <p>Article no.: 3837 Plug & Play extension lead 350 mA Dimensions: 2,000 mm</p> |