

Maßskizze / dimensional drawing

Benennung: Anbausteckdose gerade IP67 60x60

description: Flanged socket straight IP67 60x60

Teilenummer / part number: 3132-*f6

PCE

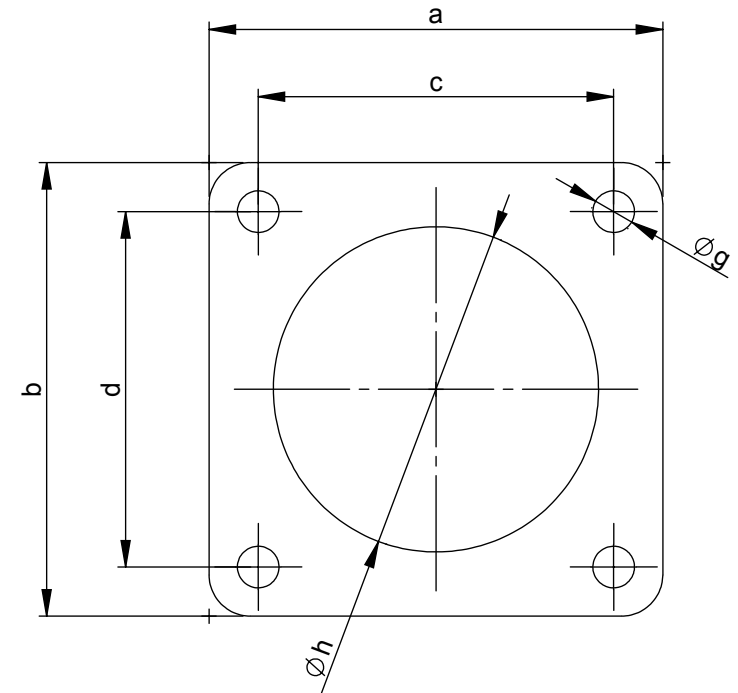
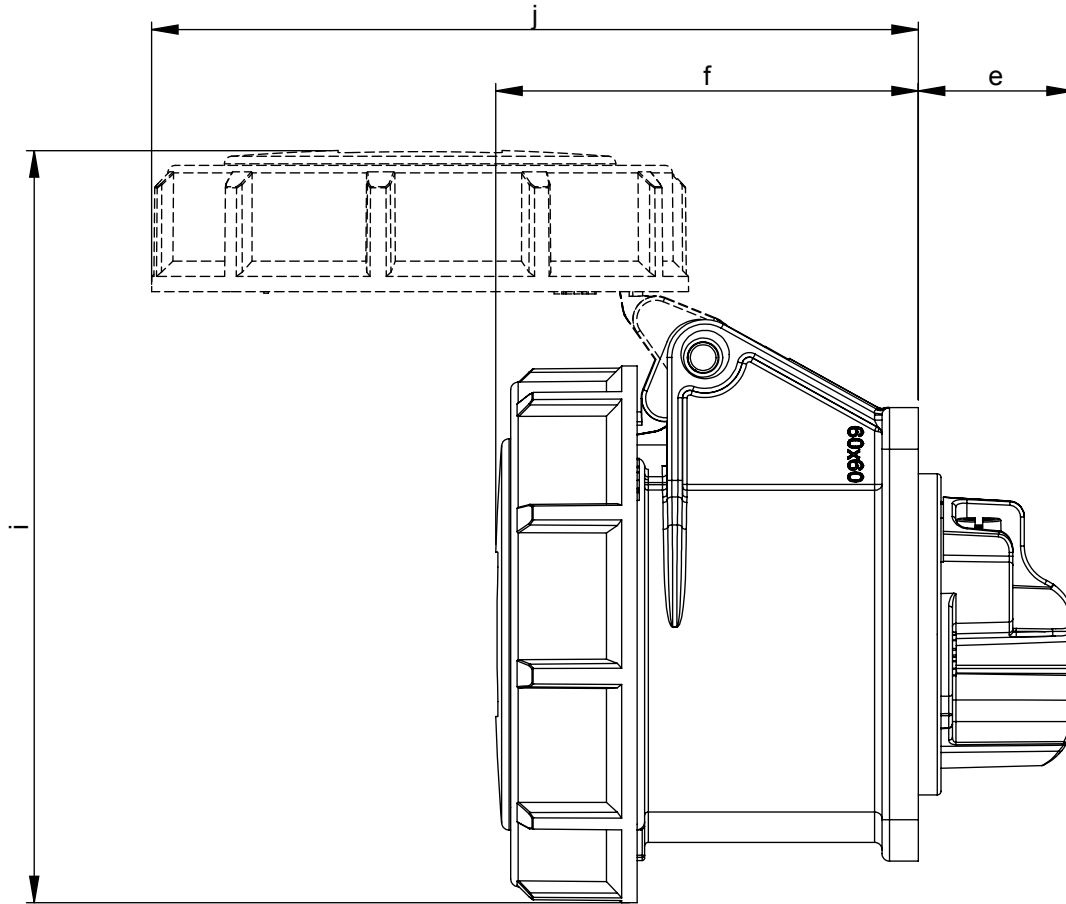

Ampere	16		
Pole	3	4	5
a x b [mm]	60	-	-
c x d [mm]	47	-	-
e [mm]	21	-	-
f [mm]	56	-	-
g [mm]	5,5	-	-
h [mm]	43	-	-
i [mm]	100	-	-
j [mm]	101	-	-