

hood upper part

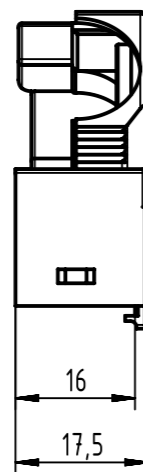

hood lower part

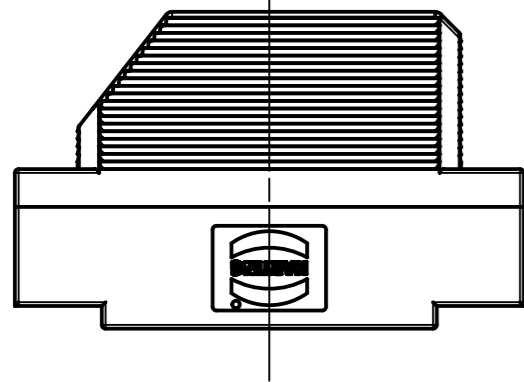
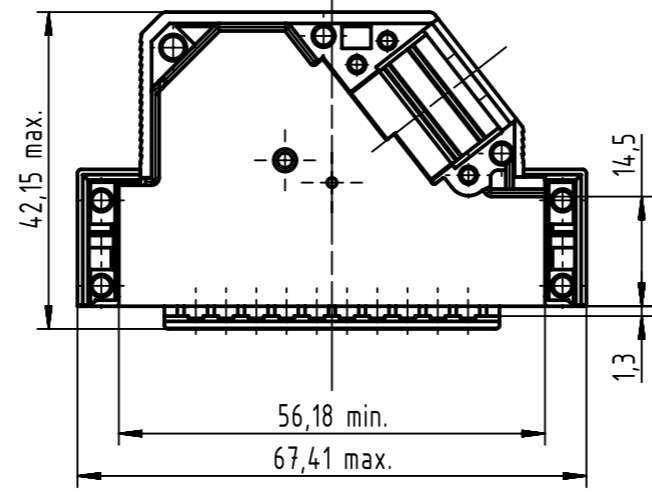

Strain relief 1



Strain relief 2

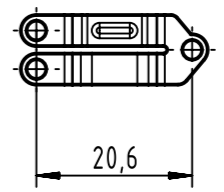
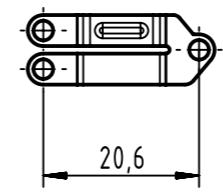

Flathead screws (2:1)

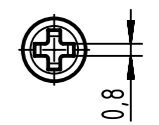
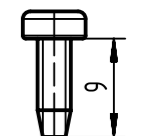

	All rights reserved Department EC PD - CN HARTING Electronics GmbH D-32339 Espelkamp	All Dimensions in mm Original Size DIN A3		Scale 1:1	Free size tol.	Ref. Sub.
		Created by ZHUANGJ	Inspected by LUOK	Standardisation HOFFMANN	Date 2016-08-31	State Final Release
		Title D-Sub hoods 50-pole without shielded				Doc-Key / ECM-Nr. 100688303/UGD/000/A 500000108369
		Type TB	Number 09670500571		Rev. A	Page 1/1