

- a) Universalboden drehbar
- b) Durchgangsloch ausbrechbar

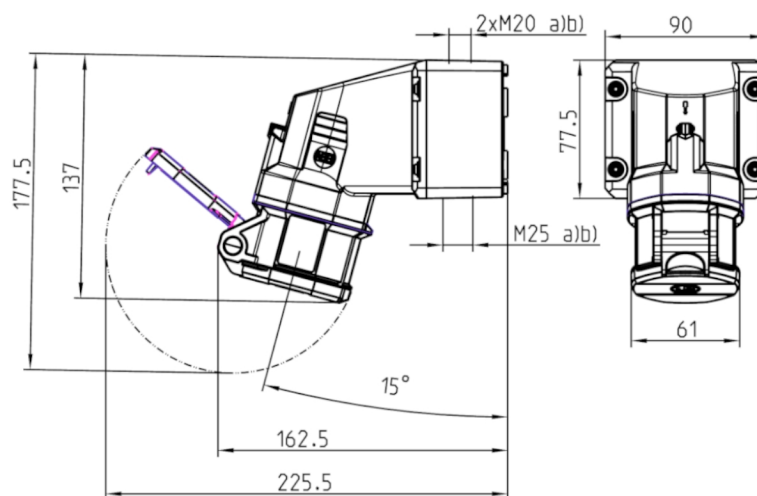

Uhrzeitstellung: 5h

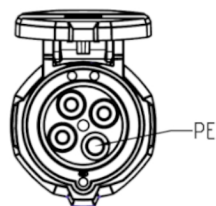

Bohrbild a)

