

Maßskizze / dimensional drawing

Benennung: Anbausteckdose gerade IP44 65x65

description: Flanged socket straight IP44 65x65

Teilenummer / part number: 313-*f0, 314-*f0

PCE

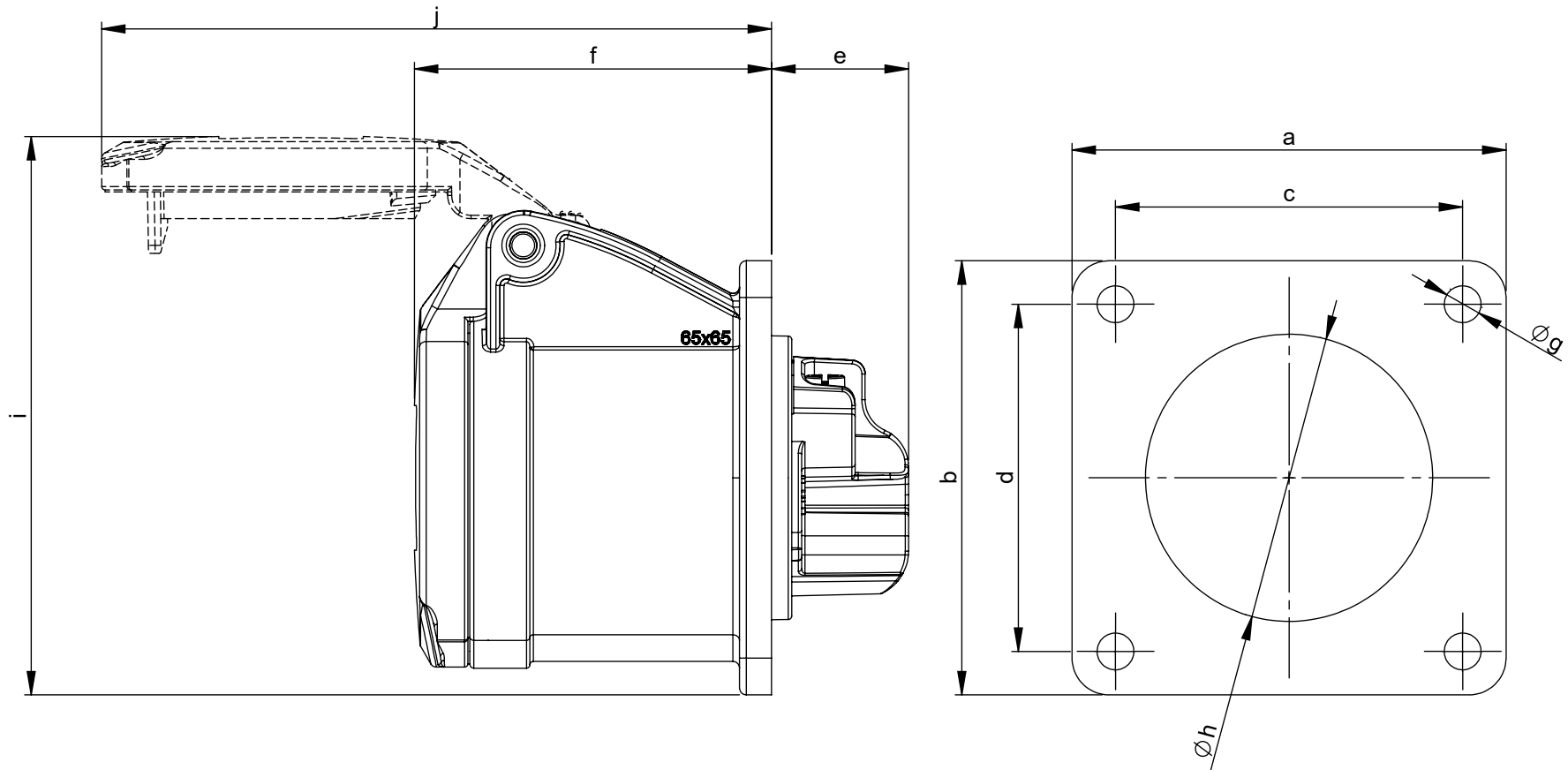

Ampere	16		
Pole	3	4	5
a x b [mm]	65	65	-
c x d [mm]	52	52	-
e [mm]	21	21	-
f [mm]	55	55	-
g [mm]	5,5	5,5	-
h [mm]	43	45	-
i [mm]	84	99	-
j [mm]	101	100	-