

Montageanleitung

Ⓒ mounting instruction Ⓕ Notice de montage Ⓖ Instrukcja montażu
Ⓔ Instrucciones de montaje Ⓘ Istruzioni di montaggio

SALI...

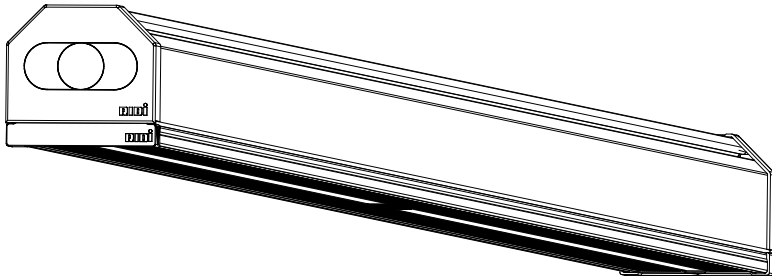

RIDI Leuchten GmbH
Hauptstrasse 31 - 33 · D-72417 Jungingen
Tel. 07477/872-0 · Fax 07477/872-48
kontakt@ridi-group.de · www.ridi-group.com



- (D) Für die Installation und für den Betrieb der Leuchten sind die nationalen Sicherheitsvorschriften zu beachten.
- (GB) Please note national safety instructions for installation and operation of this luminaire.
- (F) Pour l'installation et le fonctionnement des luminaires il est impératif de respecter les normes nationales de sécurité en vigueur.
- (PL) W celu prawidłowej instalacji i poprawnego działania oprawy należy przestrzegać krajowych przepisów bezpieczeństwa.
- (E) Para la instalación y la puesta en funcionamiento de las luminarias deben observarse las normas nacionales de seguridad.
- (I) Per l'installazione e il funzionamento delle lampade si fa riferimento alle normative di sicurezza nazionali.

(D) Verwendung der Leuchte in einer Umgebung, in der eine Ablagerung von nichtleitfähigem Staub auf der Leuchte erwartet werden kann.

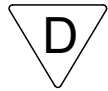

(GB) Using of the luminaire in an environment where a non-conductive deposition of dust on the luminaire is to be expected.

(F) Utilisation du luminaire dans un environnement où un dépôt de poussière non-conductrice peut être attendu.

(PL) Oprawa może być używana w otoczeniu, w którym występuje kurz. Nie powoduje elektryzowania się kurzu.

(E) Uso de la luminaria en un entorno en el que pueda producirse una acumulación de polvo no conductivo sobre la misma.

(I) Applicazione della lampada in un ambiente in cui è prevedibile il deposito di polvere oscurante sull'apparecchio.



SALI-GPS...

(D) Die Lichtquelle dieser Leuchte darf nur vom Hersteller oder einem von ihm beauftragten Servicetechniker oder einer vergleichbar qualifizierten Person ersetzt werden.

(GB) Only the manufacturer, a trained service technician or another equally qualified person is permitted to replace the light source of this luminaire.

(F) La source lumineuse de ce luminaire ne peut être remplacée que par le fabricant, un technicien de service mandaté par celui-ci ou une personne présentant une qualification analogue.

(PL) Wymiany źródła światła w tej oprawie oświetleniowej może dokonać wyłącznie producent bądź uprawniony pracownik serwisu albo osoba o podobnych kwalifikacjach.

(E) La fuente de luz de esta luminaria solamente podrá ser sustituida por el fabricante o una persona designada por este, ya sea un técnico de servicio u otra persona debidamente cualificada.

(I) La sorgente luminosa di tale lampada può essere sostituita solo dal produttore o da un tecnico di assistenza da questi designato oppure da personale dotato di qualifica equivalente.

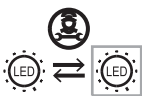
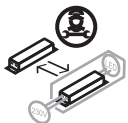

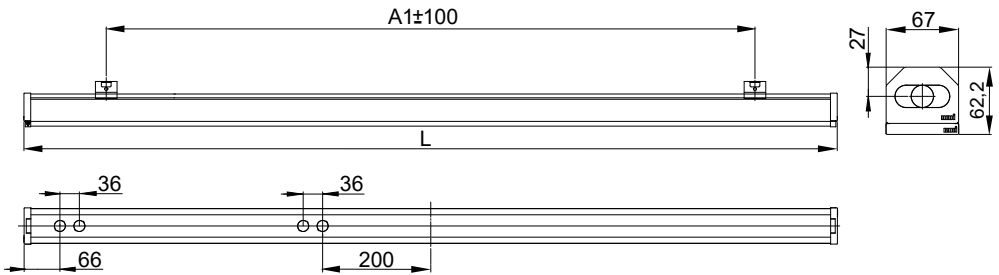
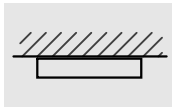
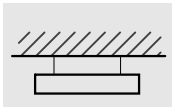

Type	L	A1		IP
SALI-GL150...	1504	1200	200	IP20
SALI-GPS150...	1504	1200	200	IP54

Type

6/8

VLTHB



6/8

TRA 008



6/8

VLBP



6/8

VLKH



5/8

VLTHSD



6/8

VLTHA



Type

5/8

VLTHD



5/8

VLTHD-H01



VLTLA



6/8

VLTLIK



6/8

ZADV...



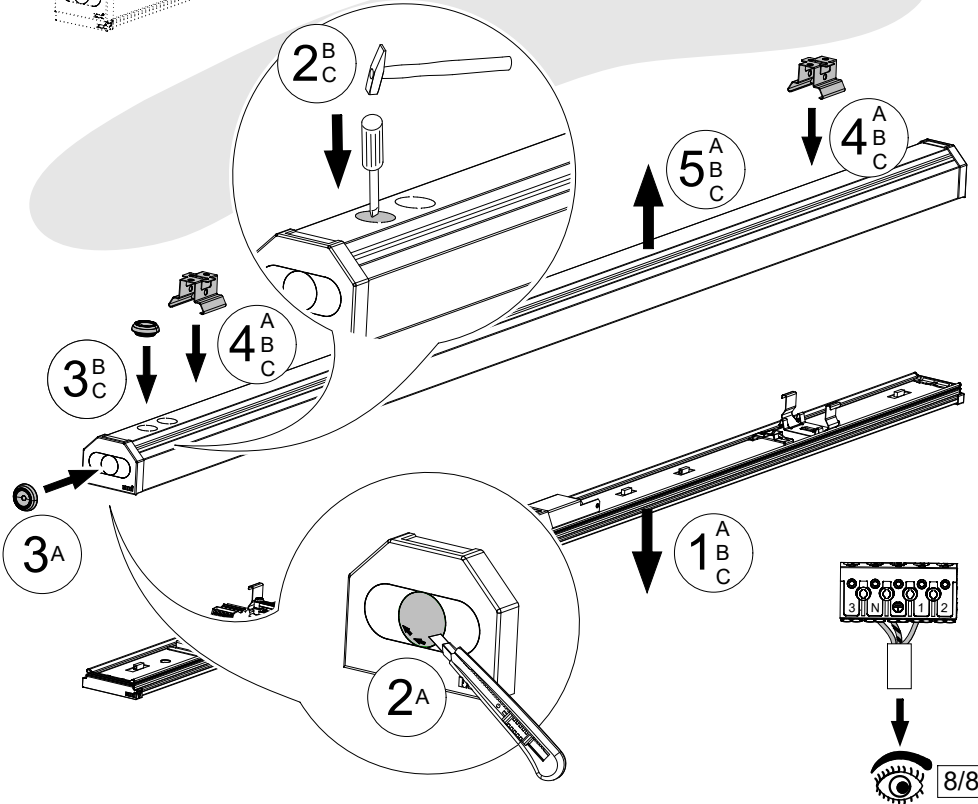
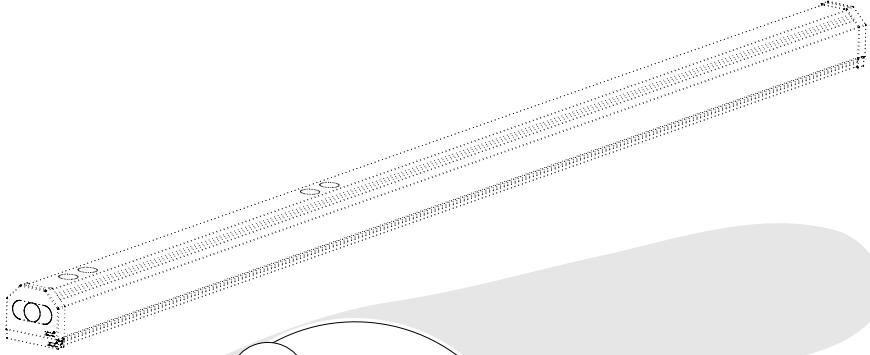
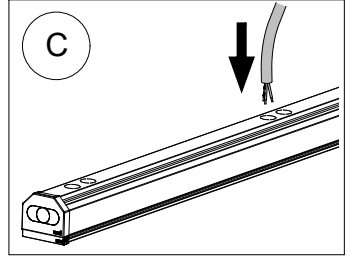
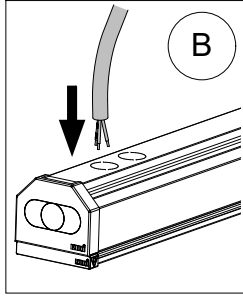
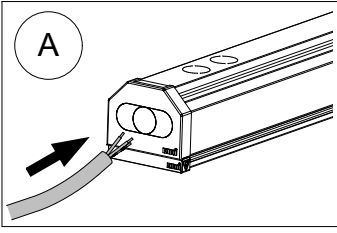

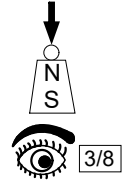
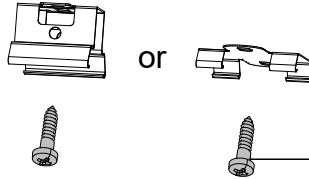
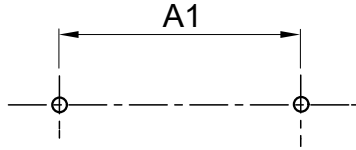
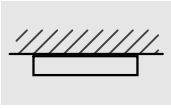

bauseits
to be supplied on-site
À prévoir sur place
we własnym zakresie
por parte del cliente
a cura del cliente

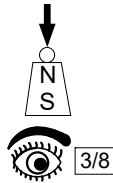
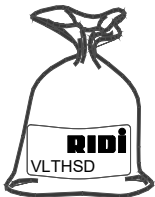
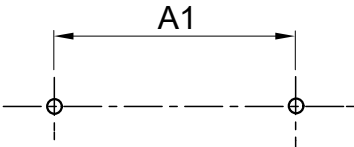
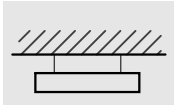
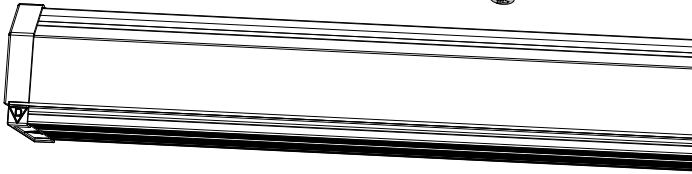

bauseits
to be supplied on-site
À prévoir sur place
we własnym zakresie
por parte del cliente
a cura del cliente

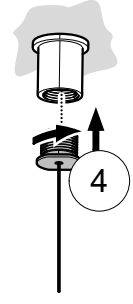
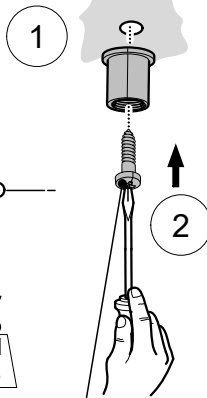

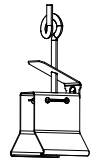
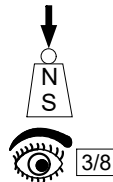
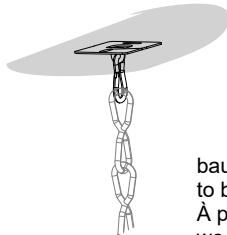
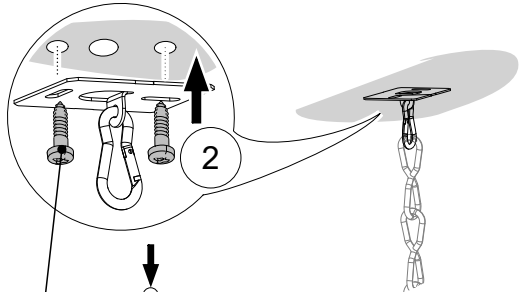
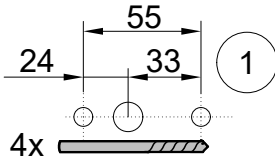
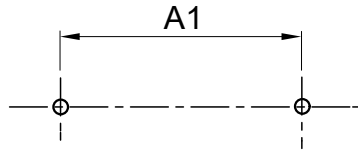
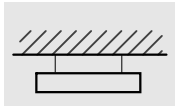

0205792	VLTHA
0205685	VLTHB
0200251	TRA 008
0205887	VLBP
0205888	VLKH

bauseits
to be supplied on-site
À prévoir sur place
we własnym zakresie
por parte del cliente
a cura del cliente

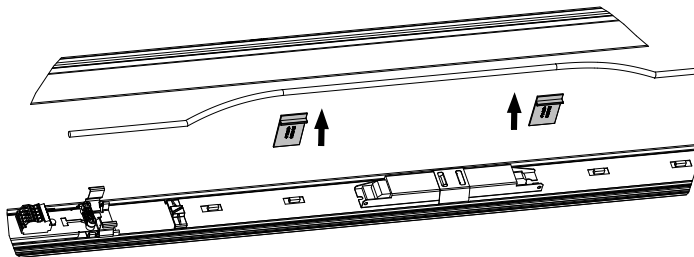
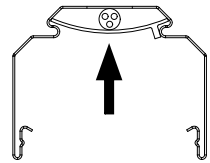



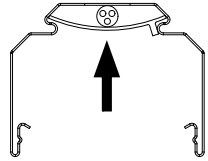

B

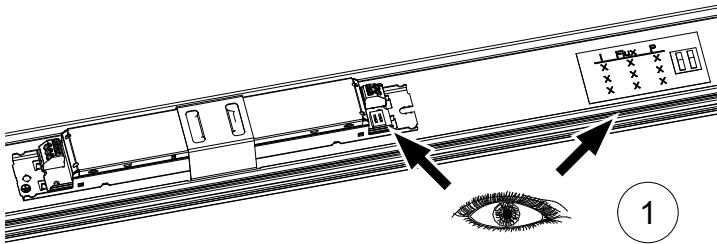
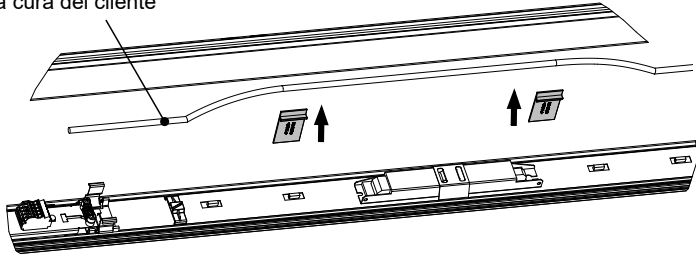

bauseits
to be supplied on-site
À prévoir sur place
we własnym zakresie
por parte del cliente
a cura del cliente

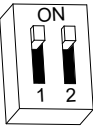
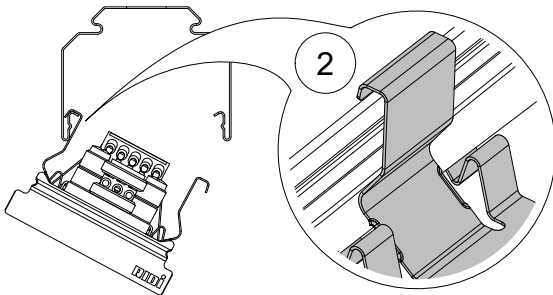

Pos	I (mA)	Flux (lm)	P (W)
 1 2	X	X	X
 1 2	X	X	X
 1 2	X	X	X
 1 2	X	X	X

ABC  4/8

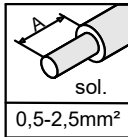
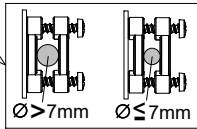
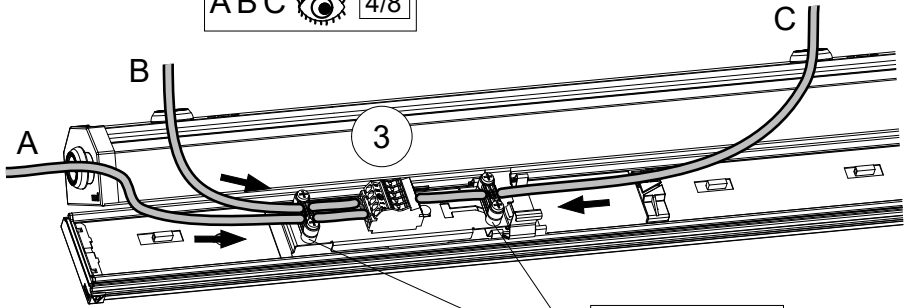

mm ²	A
0,5-1,0	9
0,5-2,5mm ²	12

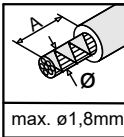

Ø	A
0,8-1,2	9
max. ø 1,8mm	12

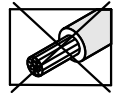

4

??V / ??Hz



RIDI
..... V
..... Hz

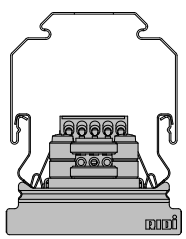
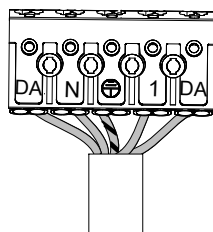
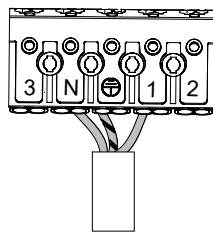

5