

Wall mounting socket outlet - housing dimensions 80x70



Product description	
BALS-Prd.-Nr	410
EAN	4024941004107
Product category	Wall mounting socket outlet, extra-low voltage
Current	16A
Number of poles	2p
Poles	2P
Position of earth contact	no minor keyway
Voltage	20 up to 25v
Frequency	50 and 60Hz

Product description	
Protection degree	IP44
Colour code	violet RAL 4005
Colour of appliance	Housing bottom grey RAL 7035, Housing top grey RAL 7035, Hinged lid violet RAL 4005, Collar grey RAL 7035
Connection design	with screw terminal
Maximum conductor size	10,0 qmm
Cable entry	top entry M25
Height	113mm
Width	70mm
Depth	79mm
Dimension of enclosure	80x70 mm (HxW)
Material of enclosure	Polyamide
Contact	The contact carrier is made of polyamide, the contacts are brass nickel plated

Additional technical properties	
	The cable entry is one at top open

Logistics data	
Weight/pcs	0.177 kg / Piece
Packaging	Bag
Content amount	1 ST
EAN	4024941004107

Logistics data	
Length	79 mm
Width	70 mm
Height	113 mm
Weight	0.178 kg
Volume	624.89 ccm
Packaging	Carton
Content amount	10 ST
EAN	4024941003568
Length	245 mm
Width	177 mm
Height	185 mm
Weight	1.903 kg
Volume	7,140 ccm

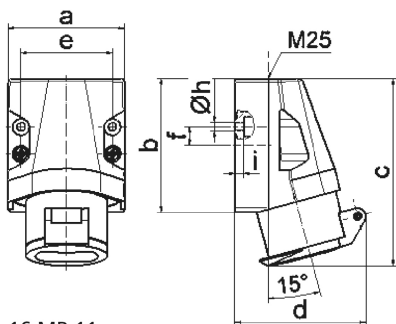

Ampere	16	16	32	32		
Polzahl	2	3	2	3		
a	70,0	70,0	70,0	70,0		
b	80,0	80,0	80,0	80,0		
c	113,0	113,0	113,0	113,0		
d	80,0	80,0	80,0	80,0		
e	55,0	55,0	55,0	55,0		
f	11,0	11,0	11,0	11,0		
h ø	5,2	5,2	5,2	5,2		
i	5,0	5,0	5,0	5,0		
Leiter mm ² min	4	4	4	4		
Leiter mm ² max	10	10	10	10		