

- a) Universalboden drehbar
- b) Durchgangsloch ausbrechbar

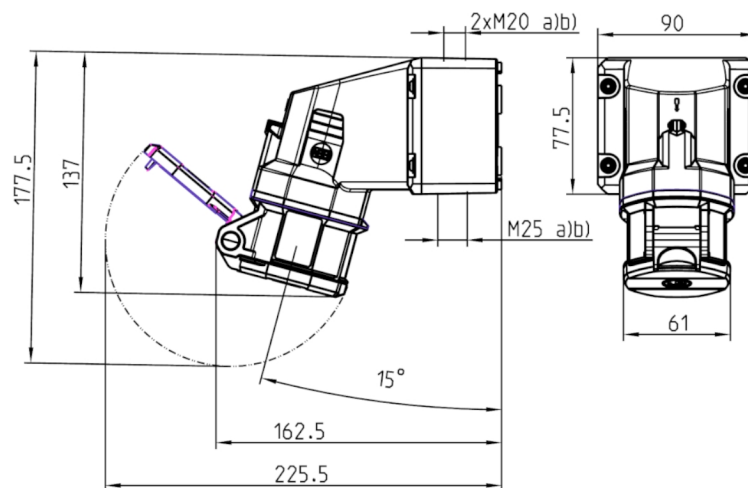

Uhrzeitstellung: 1h

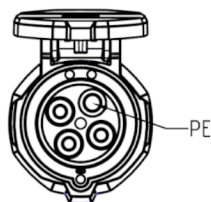

Bohrbild a)

