

LK-LED 045.1040.1405.1/DALI



Beschreibung

- Lichteinsatz aus Stahlblech mit integrierten LED-Modulen
- keine UV- und Wärmestrahlung
- nahezu alle Lichtbandlängen realisierbar
- inklusive Leitung-Set (5-polig)
- gewölbter Acrylglasdiffusor für homogene Lichtverteilung
- werkzeugloses Einrasten in Profil
- 5-polige Anschlussklemme, konfektioniert für 5-polige Durchgangsverdrahtung
- Betriebsgerät (LED-Konverter DALI, dimmbar) integriert

Hinweise

Die thermische Längenausdehnung des Aluminiumprofils beträgt bei $dT = 10$ Kelvin 0.3 mm pro Meter.

Standardoptionen



Sonderoptionen



Farbe	Artikelnummer	EAN
	662907	4043544719607

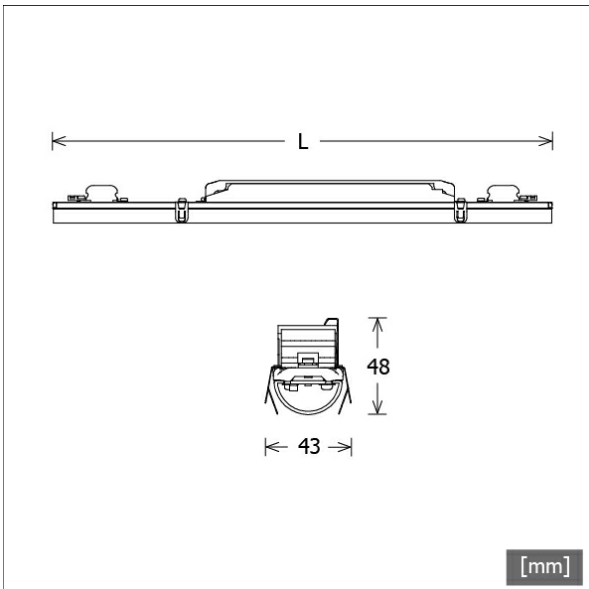

Lichttechnik / Normen

Leuchtmittel	LED linear / CRI 80 / max. 4000 K
Lebensdauer	L90 B50 50.000 h L80 B50 100.000 h L80 B20 50.000 h
Systemleistung	32.2 W
Leuchten-Lichtstrom	max. 3560 lm
Systemeffizienz	101.55 lm/W
Moduleffizienz	164.17 lm/W
UGR 4H/8H 70/50/20	25.8/26.1 (C0/C90)
Versorgungsspannung	220 - 240 V / 50 Hz
Schutzklasse	I

Abmessungen / Gewichte

Länge	1405 mm
Breite	43 mm
Höhe	48 mm
Nettogewicht	1.43 kg
Bruttogewicht	1.50 kg

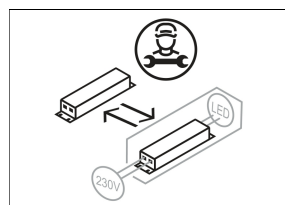
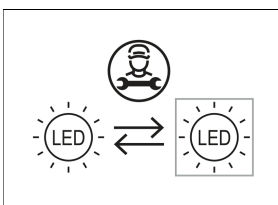

LK-LED 045.1040.1405.1/DALI

LK-LED 045.1040.1405.1/DALI

Lichtkanal 045 | Light-Insert (AOB, 1xLED 32W 840/4000K 3270lm)

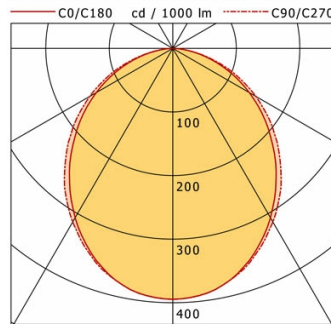

	C0	C90	C180	C270
0°	395	395	395	395
15°	372	373	372	373
30°	308	315	308	315
45°	225	238	225	238
60°	139	152	139	152
75°	57	62	57	62
90°	0	0	0	0
cd / 1000 lm				

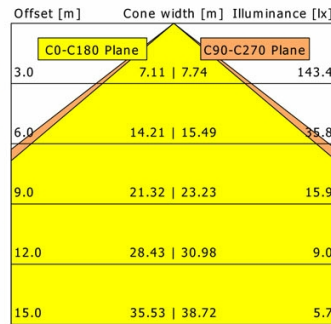

η	LED
Efficiency	102 lm/W
Direct/Indirect	↓ 100% / ↑ 0%
System Power	32 W
UGR	X=4H, Y=8H
Reflection factors	70/50/20
UGR C0/C180	25.8
UGR C90/C270	26.1
CIE Flux Codes	50 81 96 100 100
Ra/CRI	>80

LTS

LK-LED 045.1040.1405.1/DALI

Lichtkanal 045 | Light-Insert (AOV-001/003/005.1, 1xLED 32W 840/4000K 3560lm)

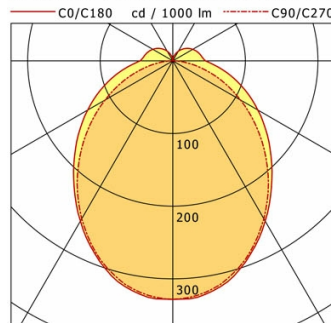

	C0	C90	C180	C270
0°	328	328	328	328
30°	255	251	255	251
60°	135	108	135	108
90°	45	2	45	2
120°	32	1	32	1
150°	15	1	15	1
180°	0	0	0	0
cd / 1000 lm				

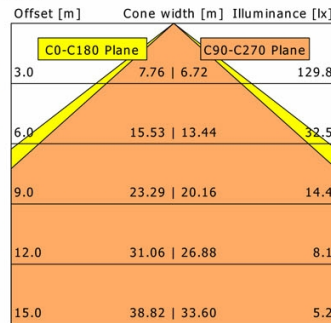

η	LED
Efficiency	111 lm/W
Direct/Indirect	↓ 89% / ↑ 11%
System Power	32 W
UGR	X=4H, Y=8H
Reflection factors	70/50/20
UGR C0/C180	27.6
UGR C90/C270	24.7
CIE Flux Codes	46 75 92 89 100
Ra/CRI	>80

LTS

LK-LED 045.1040.1405.1/DALI

Lichtkanal 045 | Light-Insert (APB, 1xLED 32W 840/4000K 3120lm)

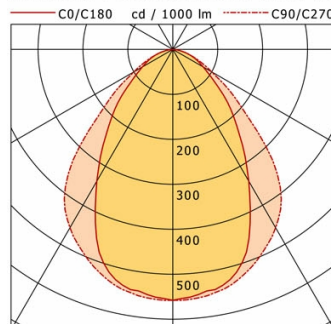

	C0	C90	C180	C270
0°	558	558	558	558
15°	522	536	522	536
30°	338	458	338	458
45°	178	279	178	279
60°	78	100	78	100
75°	31	30	31	30
90°	0	0	0	0
cd / 1000 lm				

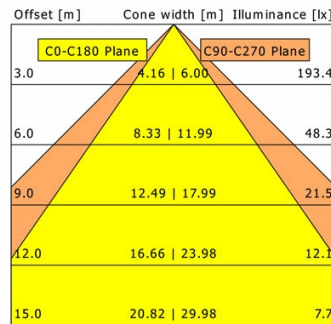

η	LED
Efficiency	98 lm/W
Direct/Indirect	↓ 100% / ↑ 0%
System Power	32 W
UGR	X=4H, Y=8H
Reflection factors	70/50/20
UGR C0/C180	22.1
UGR C90/C270	22.9
CIE Flux Codes	65 90 98 100 100
Ra/CRI	>80

LTS

LK-LED 045.1040.1405.1/DALI

Lichtkanal 045 | Light-Insert (AOV-002/005.2, 1xLED 32W 840/4000K 3560lm)

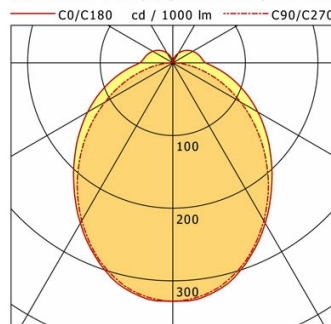

	C0	C90	C180	C270
0°	328	328	328	328
30°	255	251	255	251
60°	135	108	135	108
90°	45	2	45	2
120°	32	1	32	1
150°	15	1	15	1
180°	0	0	0	0
cd / 1000 lm				

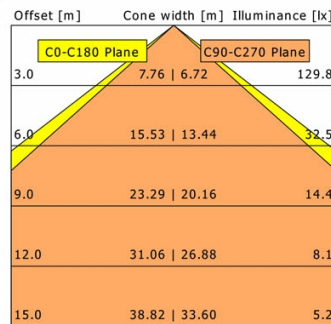

η	LED
Efficiency	111 lm/W
Direct/Indirect	↓ 89% / ↑ 11%
System Power	32 W
UGR	X=4H, Y=8H
Reflection factors	70/50/20
UGR C0/C180	27.6
UGR C90/C270	24.7
CIE Flux Codes	46 75 92 89 100
Ra/CRI	>80

LTS