

Cell Type CR17450SE Specifications

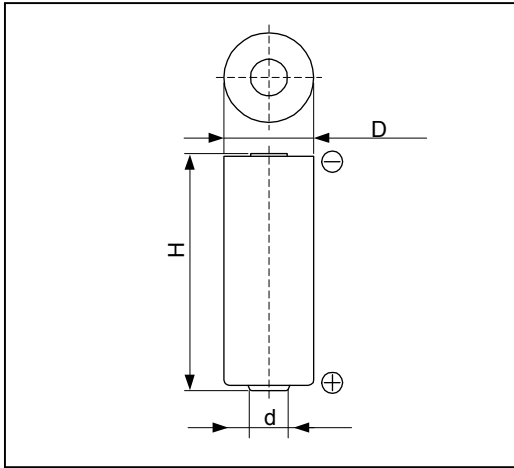

Nominal Capacity ^{*1}		2500mAh
Nominal Voltage		3V
Standard Discharge Current		1.0mA
Max. Discharge Current	Continuous ^{*2}	9mA
	Pulse ^{*3}	150mA
Temperature Range		-40°C ~ 85°C
Weight		22g
Dimensions	D	17.0mm
	H	45.0mm
	d	7mm

*1 Nominal capacity is determined to an end voltage of 2.0V when the battery is allowed to discharge at a standard current level at 23°C.

*2 Current value is determined to be the level at which 50% of the nominal capacity is obtained with an end voltage of 2.0V at 23°C.

*3 Current value for obtaining 2.0V cell voltage when pulse is applied for 15seconds at 50% discharge depth at 23°C.

Typical Characteristics

Discharge Characteristics of CR17450SE

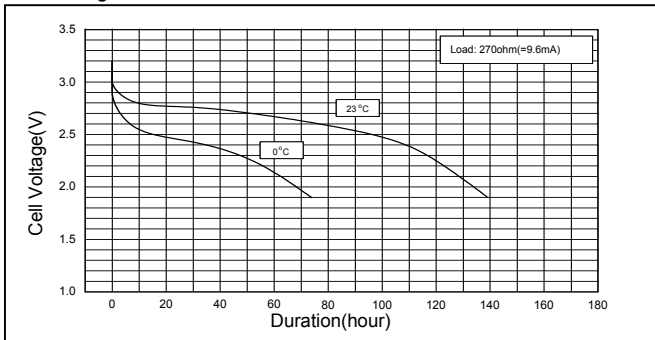

Discharge Characteristics of CR17450SE

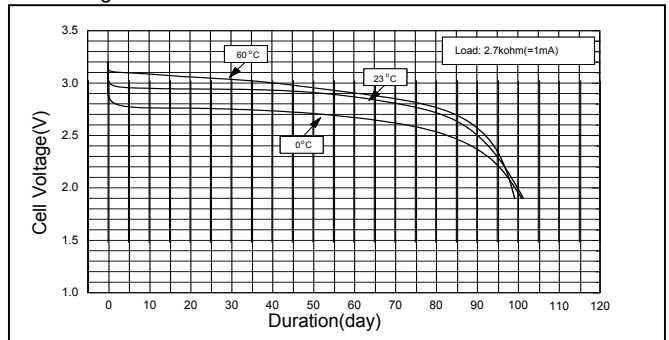

Discharge Characteristics of CR17450SE

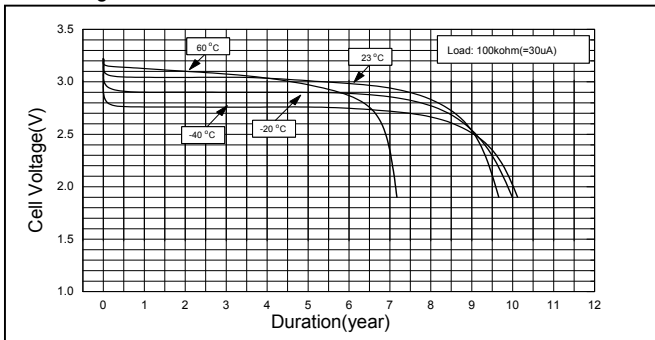

Discharge Load vs. Capacity of CR17450SE

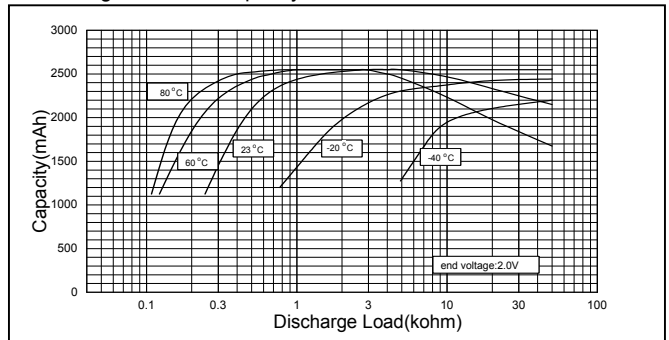

Discharge Load vs. Operating Voltage of CR17450SE

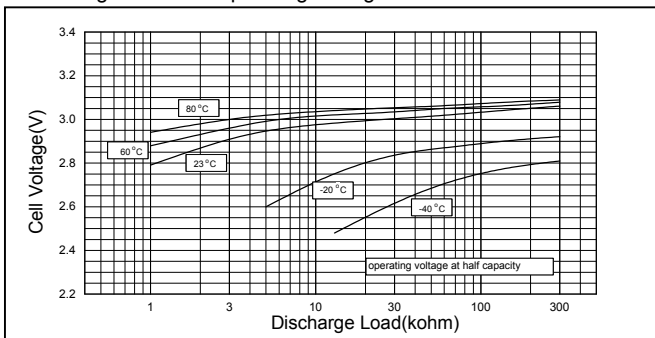

Discharge Characteristics of CR17450SE

