

Matric-F3

Recessed mounted light line, mounting brackets incl - Direct light distribution

Article code: LF3OEE-830M-L905



Illustrations may only be similar and serve as an orientation.

Matric-F3. LED. Recessed mounted light line with surrounding frame for installation in sawn wall and ceiling with cut-out openings. Mounting brackets included. Luminaire body made of high-quality aluminum profile. Surface finish Silver Anodised. Direct only light distribution. Colour temperature: 3000K (Warm White). Colour Rendering Index (CRI): >80. Opal diffuser for enhanced light transmission and perfect uniform illumination. Switchable. LxWxH (rectangular). L= 905mm. W=70mm. H=75mm.

Medium-power current. 1777lm. 16W. 2,4kg. Binning initial \leq MacAdam 3. IP20. Protection class I. CE, UKCA marking. Prüfzeichen: ENEC. IK02. 220-240V. 50-60 Hz. RG0 (EN62471). Luminous flux reduction up to 0,3%/1.000 operating hours. Nominal failure rate: 0,2%/1.000 operating hours. L85B10 (tq 25°C) = 50.000h. 5 years warranty. Manufacturer: Lightnet GmbH, ISO 9001:2015 and 50001:2018 certified.

Matric-F3

Recessed mounted light line, mounting brackets
incl - Direct light distribution

Article code: LF3OEE-830M-L905

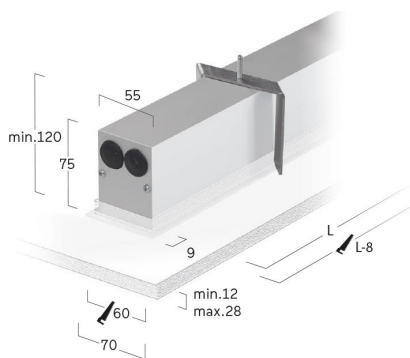
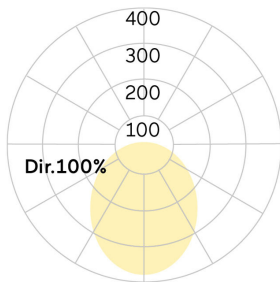

Customer / Project: _____

Note: _____

Productname	Matric-F3
Lamp	LED
Installation Type	Recessed mounted light line, mounting brackets incl
Surface finish	Silver Anodised
Light characteristics	Direct light distribution
Colour temperature	3000K
Colour Rendering Index (CRI)	CRI>80
Optical system	Opal diffuser
Control	Switchable
Length L/Diameter D (mm)	L=905mm
Width W (mm)	W=70mm
Height H (mm)	H=75mm
Current/Power	Medium-Power
Luminous Flux	1777lm
Power consumption	16W
Degree of protection	IP20
Certification	Prüfzeichen: ENEC
LED lifetime	L85B10 (tq 25°C) = 50.000h
Photometric code	8 30 / 3 3 9
Photobiological class	RG0 (EN62471)
Indoor/Outdoor	Indoor: ta [ambient] max. 25°C
Weight (kg)	2,4kg

