

## Matric-F5

Recessed mounted light line, mounting brackets incl - Direct light distribution

Article code: LF5AEL-830M-L1490

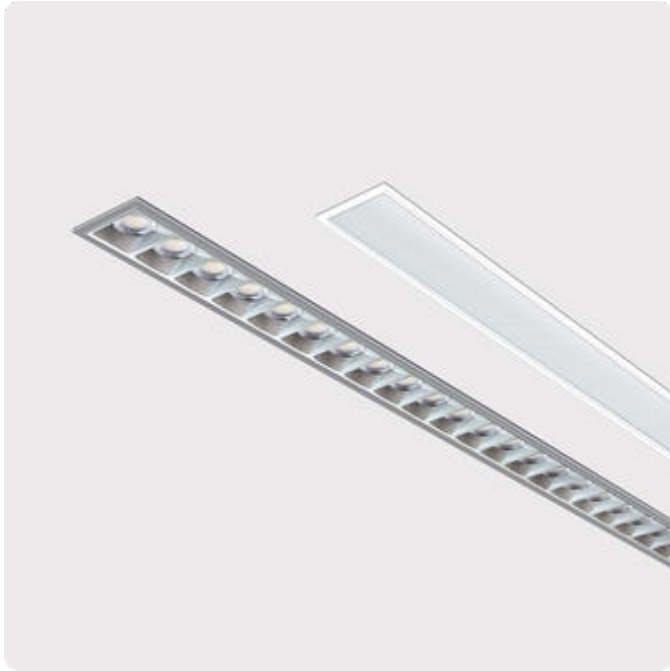

Illustrations may only be similar and serve as an orientation.

Matric-F5. LED. Recessed mounted light line with surrounding frame for installation in sawn wall and ceiling with cut-out openings. Mounting brackets included. Luminaire body made of high-quality aluminum profile. Surface finish Silver Anodised. Direct only light distribution. Colour temperature: 3000K (Warm White). Colour Rendering Index (CRI): >80. Microprismatic screen for uniform illumination and reduced luminance in office areas. Dimmable DALI. LxWxH (rectangular). L=1490mm. W=

100mm. H=90mm. Medium-power current. 3226lm. 32W. 4,9kg. Binning initial <= MacAdam 3. IP20. Protection class I. CE, UKCA marking. Prüfzeichen: ENEC. IK02. 220-240V. 50-60 Hz. RG0 (EN62471). Luminous flux reduction up to 0,3%/1.000 operating hours. Nominal failure rate: 0,2%/1.000 operating hours. L85B10 (tq 25°C) = 50.000h. 5 years warranty. Manufacturer: Lightnet GmbH, ISO 9001:2015 and 50001:2018 certified.

## Matric-F5

Recessed mounted light line, mounting brackets  
incl - Direct light distribution

Article code: LF5AEL-830M-L1490



Customer / Project: \_\_\_\_\_

Note: \_\_\_\_\_

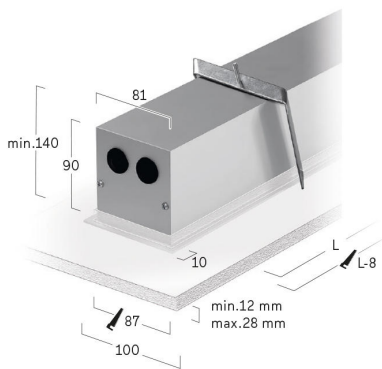
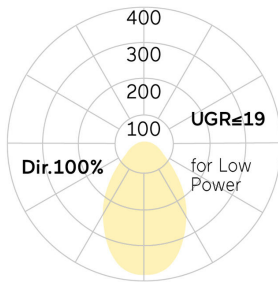

Productname	Matric-F5
Lamp	LED
Installation Type	Recessed mounted light line, mounting brackets incl
Surface finish	Silver Anodised
Light characteristics	Direct light distribution
Colour temperature	3000K
Colour Rendering Index (CRI)	CRI>80
Optical system	Microprismatic screen
Control	Dimmable (DALI)
Length L/Diameter D (mm)	L=1490mm
Width W (mm)	W=100mm
Height H (mm)	H=90mm
Current/Power	Medium-Power
Luminous Flux	3226lm
Power consumption	32W
Degree of protection	IP20
Certification	Prüfzeichen: ENEC
LED lifetime	L85B10 (tq 25°C) = 50.000h
Photometric code	8 30 / 3 3 9
Photobiological class	RG0 (EN62471)
Indoor/Outdoor	Indoor: ta [ambient] max. 25°C
Weight (kg)	4,9kg

