

E10752

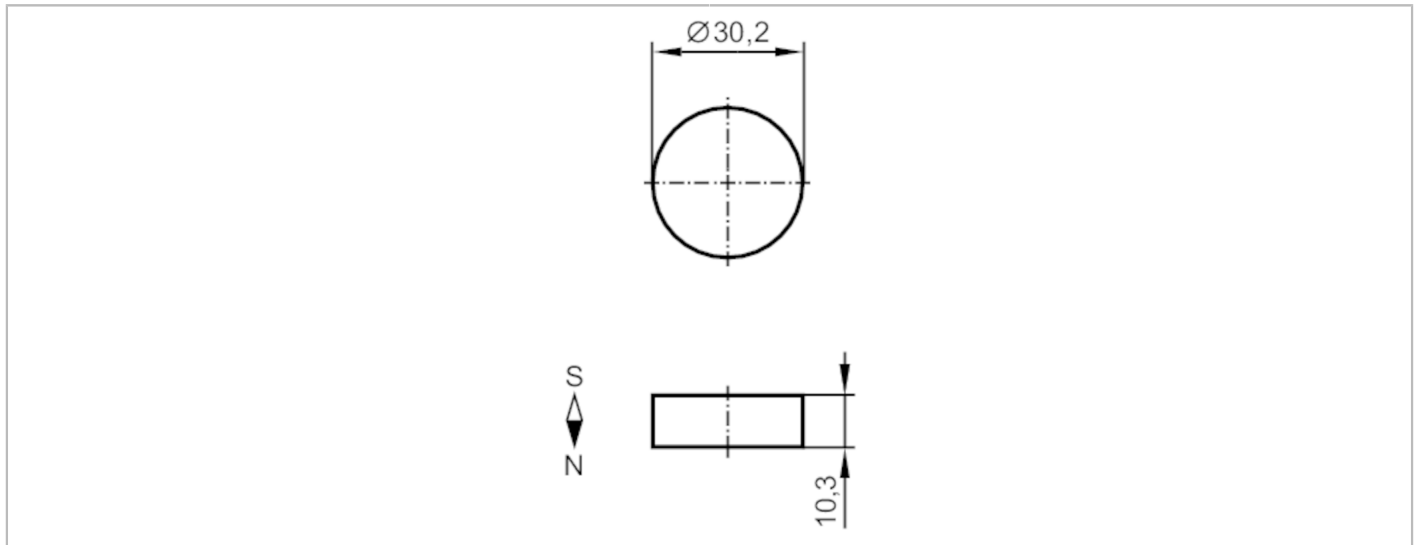

Bedämpfungsmagnet

MAGNET M4.0 HARD FERRITE



Umgebungsbedingungen		
Umgebungstemperatur	[°C]	-25...250
Mechanische Daten		
Gewicht	[g]	35,2
Abmessungen	[mm]	Ø 30 / L = 10
Werkstoffe		Hartferrit HF 24/23
Magnetfeldstärke	[mT]	80
Bemerkungen		
Verpackungseinheit		1 Stück