

Accessories sockets - 70x52

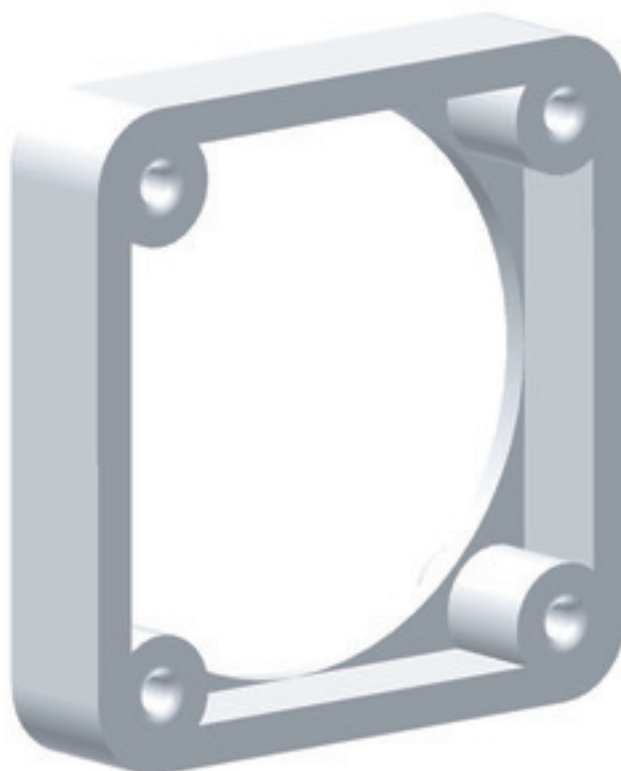

Product description	
BALS-Prd.-Nr	1852
EAN	4024941018524
product category (PG)	Mounting frame
colour code 1 (KF1)	gray RAL 7035
Height	80mm
Width	71mm
Depth	10mm
Drill hole distance vertical	52mm
Drill hole distance horizontal	70mm

Product description	
material of enclosure (GM)	Polyamide

Logistics data	
Weight/pcs	0.02 kg / Piece
Packaging	Bag
Content amount	1 ST
EAN	4024941018524
Length	10 mm
Width	71 mm
Height	80 mm
Weight	0.021 kg
Volume	56.8 ccm
Packaging	Carton
Content amount	100 ST
EAN	4024941327039
Length	275 mm
Width	175 mm
Height	137 mm
Weight	2.125 kg
Volume	5,737.5 ccm

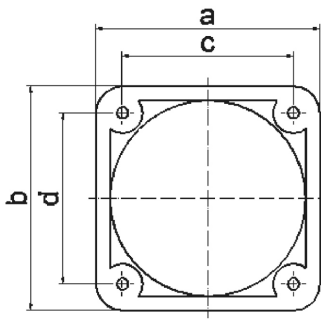

30 MB 182

a	b	c	d	e	Bestell-Nr.
50	50	38	38	13	1843
54	54	44	44	10	1847
57	66	47	47	10	1848
60	60	50	50	10	1849
62	62	52	52	10	1850
62	70	52	60	10	1851