

LED-floor recessed light, IP65
Article no. P3817Y

Light.
For Generations.

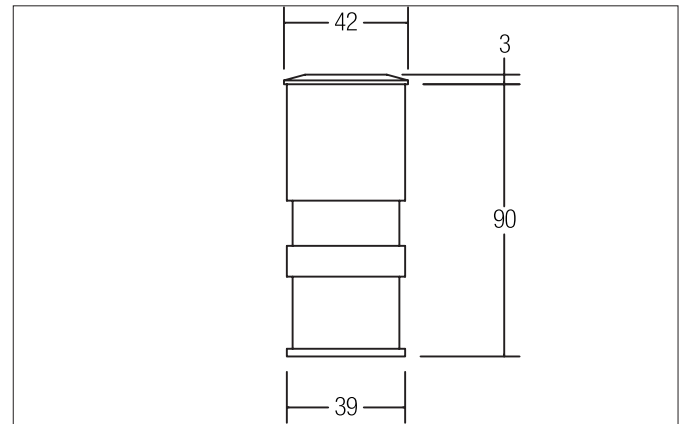
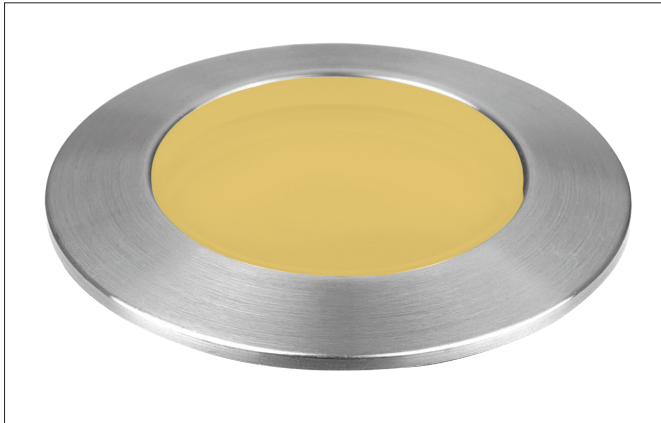

Tender

LED-floor recessed light, IP65, Round. Recessed mounting, Floor-mounted Including mounting sleeve and 150 mm connection cable
Lamp holder: Plug&Play, Mounting method: Recessed mounting, Place of installation: Floor-mounted, Material: Stainless steel / Aluminium / Plastic / Glass, Degree of protection: according to DIN EN 60529 IP65, Protection class: (EN 61140) III, Current: 350 mA, Power: 1W, Amount of light sources / fittings: 1.0 Qty, Control: Dimming depending on driver.

Article data	
Article no.	P3817Y
GTIN	4250047742180
Short description	LED-floor recessed light, IP65
Material	Stainless steel / Aluminium / Glass
Colour	Stainless steel
Shape	Round
Built-in diameter	39 mm
Installation depth	90 mm
Weight	0.170 kg

Lighting technology	
Colour rendering	CRI > 80





LED-floor recessed light, IP65
Article no. P3817Y

Light.
For Generations.

Operating technology of the luminaire	
Current	350 mA
Lamp	LED
Lamp holder	Plug&Play
Protection class	III
Degree of protection	IP65
Control	Dimming depending on driver
Bulb change possible	Yes

Mounting technology	
Mounting method	Recessed mounting
Place of installation	Floor-mounted
Adjustability	Not adjustable

Packing data	
Gross weight	0.204 kg
Length of packaging	90 mm
Packaging width	55 mm
Packaging height	109 mm
Disposal at end of life	This product must not be disposed of with household waste. You are obliged, to dispose of such electrical waste separately. By disposing of electrical waste and other old or defective electronics separately, you support recycling or other forms of re-use. In that way you help to take care and to avoid that harmful substances get into the environment.

Accessories	
	Article no.: 17666000 LED converter 350 mA, on/off switchable Power: 1 - 5 W Dimensions: 52 mm x 30 mm x 23 mm
	Article no.: 17662020 LED converter 350 mA, on/off switchable Power: 1 - 7,2 W Dimensions: 68 mm x 35 mm x 21 mm
	Article no.: 17613000 LED converter 350 mA, on/off switchable Power: 1 - 15 W Dimensions: 115 mm x 34 mm x 19 mm
	Article no.: 17621020 LED converter 350 mA, on/off switchable Power: 1 - 21 W Dimensions: 128 mm x 50 mm x 13 mm
	Article no.: 17648020 LED converter 350 mA, trailing-edge phase dimmable Power: 0,7 - 17 W Dimensions: 166 mm x 46 mm x 34 mm