

# INSTRUCTION

## SHX

### SHXI/SHPI

# STAIL LED

6030  
6031



# REGIOLUX

Regiolux GmbH  
Hellinger Str. 3  
D-97486 Königsberg/Bay.  
T 09525 89-0  
<http://www.regiolux.de>  
info@regiolux.de



Diese Leuchte enthält ein Leuchtmittel der Energieeffizienzklasse C  
This lamp contains a lamp of the Energy efficiency class C

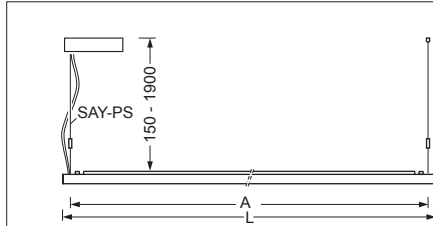

|                | L    | A    |
|----------------|------|------|
| SH./SH.I /1200 | 1240 | 1216 |
| SH./SH.I /1500 | 1540 | 1516 |

**Achtung:**  
Leuchte nicht öffnen!  
Garantieverlust!

**Attention:**  
N'est pas ouvrir le luminaire!  
Perte de garantie!

**Attention:**  
Don't open the luminaire!  
Loss of Guarantee!

**Atención:**  
Non abrir la luminara!  
Pérdida de garantía!

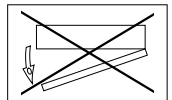

SAY-PS 1900/190

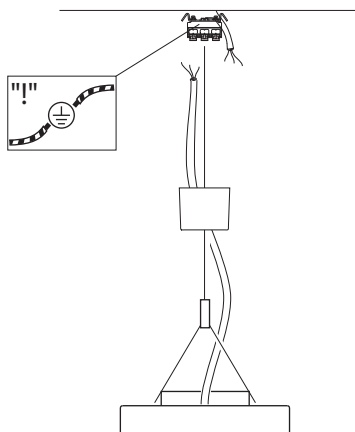
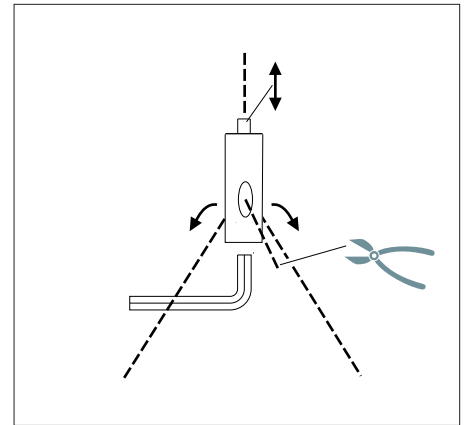
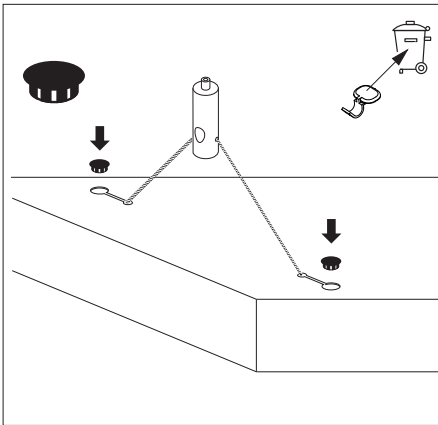
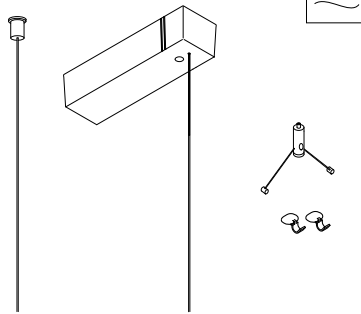

## DALI

- Ein / Aus / Dimmen -
- On / Off / Dimming -

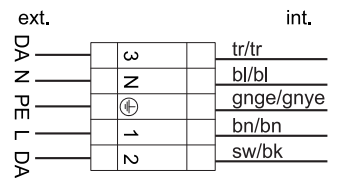
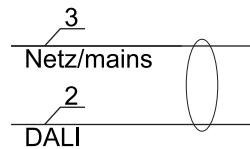

- Ein / Aus / Tast-Dim -
- On / Off / Touch dim -

