

LED power supply 24 V DC, on/off switchable

Article no. 17244000

Light.
For Generations.

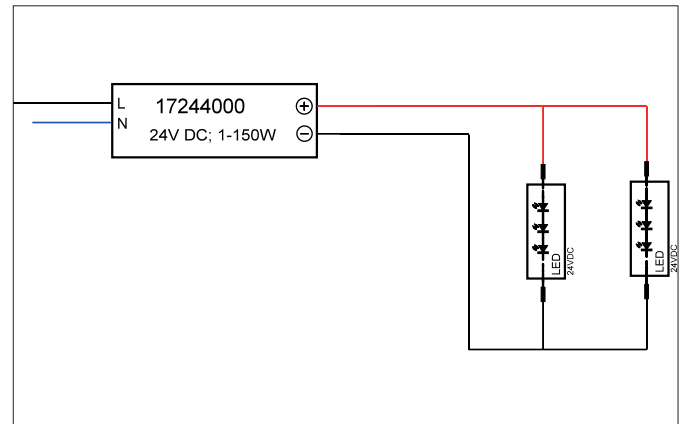

Tender

LED power supply 24 V DC, on/off switchable. Material: Plastic, Degree of protection: according to DIN EN 60529 IP20, Protection class: (EN 61140) II, Voltage: 24 V, Power: 150 W, Control: on/off.

Article data	
Article no.	17244000
GTIN	4251433939085
Short description	LED power supply 24 V DC, on/off switchable
Material	Plastic
Length	310 mm
Width	40 mm
Height	30 mm
Weight	0.485 kg

Operating technology of driver	
AC nominal voltage max	230 V
Frequenz max.	50 Hz
Protection class	II
Degree of protection	IP20
Power max.	150 W
Control	on/off
Environment temperature (ta)	-20°C up to +45°C
Measure point (tc)	max. +85°C

LED power supply 24 V DC, on/off switchable

Article no. 17244000

Light.
For Generations.

Packing data	
Gross weight	0.513 kg
Length of packaging	45 mm
Packaging width	35 mm
Packaging height	330 mm
Disposal at end of life	<p>This product must not be disposed of with household waste. You are obliged, to dispose of such electrical waste separately.</p> <p>By disposing of electrical waste and other old or defective electronics separately, you support recycling or other forms of re-use. In that way you help to take care and to avoid that harmful substances get into the environment.</p>