

Wall mounting socket outlet - with external fixing



Product description	
BALS-Prd.-Nr	11725
EAN	4024941117258
product category (PG)	Wall mounting socket outlet
current (A)	16A
number of poles (P99)	5p
number of poles (P)	3p+N+PE
position of earth contact (H)	9 h
voltage (V)	120/208 up to 144/250V
frequency (HZ)	50 and 60Hz

Product description	
protection degree (SA)	IP44
colour code 1 (KF1)	blue RAL 5015
Colour of appliance	Collar blue RAL 5015, Hinged lid blue RAL 5015, Housing bottom grey RAL 7035, Housing top grey RAL 7035
connection design (AT)	with screw terminal
maximum conductor size (LQ)	4,0 qmm
cable entry (KE)	top entry M25
Height	131mm
Width	87mm
Depth	99mm
dimension of enclosure (GG)	90x87 mm (HxW)
material of enclosure (GM)	Polyamide
contact	The contact carrier is made of polyamide, The contacts are brass

Additional technical properties	
	The cable entry is one at top open and one at bottom closed

Logistics data	
Weight/pcs	0.236 kg / Piece
Packaging	Bag
Content amount	1 ST

Logistics data	
EAN	4024941117258
Length	99 mm
Width	87 mm
Height	131 mm
Weight	0.237 kg
Volume	1,128.303 ccm
Packaging	Carton
Content amount	10 ST
EAN	4024941941105
Length	387 mm
Width	222 mm
Height	150 mm
Weight	2.553 kg
Volume	11,029.5 ccm

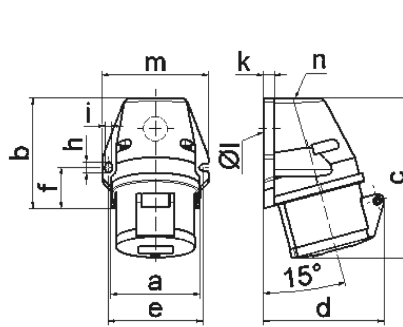

1 MB 19

Ampere Polzahl	16 3	16 4	16 5	32 3	32 4	32 5
a	59,5	72,4	72,4	79,1	79,1	79,1
b	90,0	90,0	90,0	92,0	92,0	92,0
c	130,0	130,0	131,0	142,0	142,0	142,0
d	85,0	96,0	98,0	103,0	103,0	106,0
e	62,0	77,0	77,0	84,0	84,0	84,0
f	33,5	33,5	33,5	30,0	30,0	30,0
h	9,0	9,0	9,0	9,0	9,0	9,0
i	5,5	5,5	5,5	5,5	5,5	5,5
k	8,0	9,0	9,0	9,0	9,0	9,0
l ø	21,0	21,0	21,0	21,0	21,0	21,0
m	72,0	87,0	87,0	94,0	94,0	94,0
n	M20	M25	M25	M25	M25	M25
Leiter mm ² min	1,5	1,5	1,5	2,5	2,5	2,5
Leiter mm ² max	4	4	4	10	10	10