

Transfer or duplication of this document as well as the utilisation or communication of its content are not permitted unless express consent is granted. Violations give rise to claims for damages. All rights reserved in case of patent, utility model or design patent registrations.

Weitergabe sowie Vervielfältigung dieses Dokuments, Verwertung und Mitteilung seines Inhalts sind verboten, soweit nicht ausdrücklich gestattet. Zuwiderhandlungen verpflichten zu Schadenersatz. Alle Rechte für den Fall der Patent-, Gebrauchsmuster- oder Designeintragung vorbehalten.

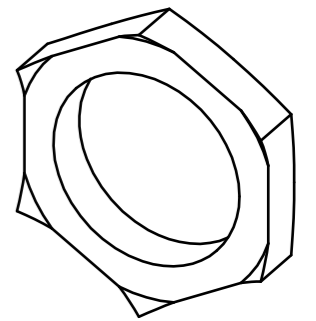
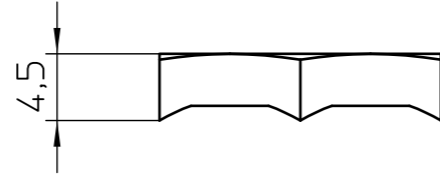
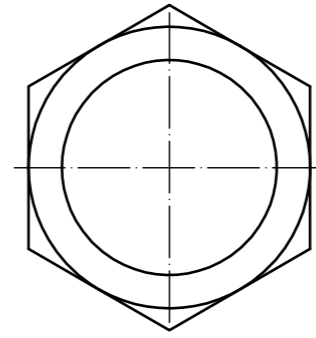
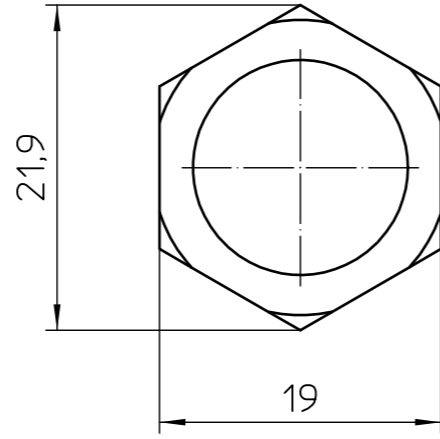

General Information

- Simplified representation
- Document excluded from change process
- Linear dimensions [mm]

	document-No. / RI	date	scale
	00784294 / 01	28.06.2021	2:1
	ident.-No.	document-type	
	1411268	TECDOC 2D_Productdrawing	
page 1	of 1	description	
		A-INLE-M16-N-S	