

# SCHALTBILDER

## DZR 35/2 B

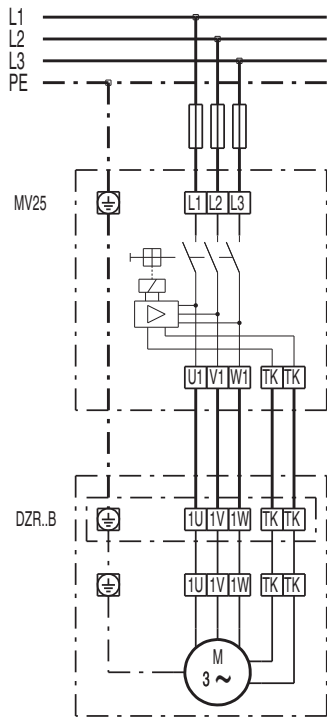

# SCHALTBILDER

## DZR 35/2 B

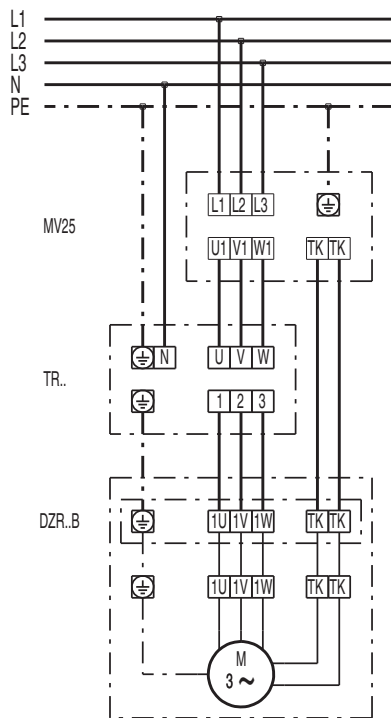

# SCHALTBILDER

## DZR 35/2 B

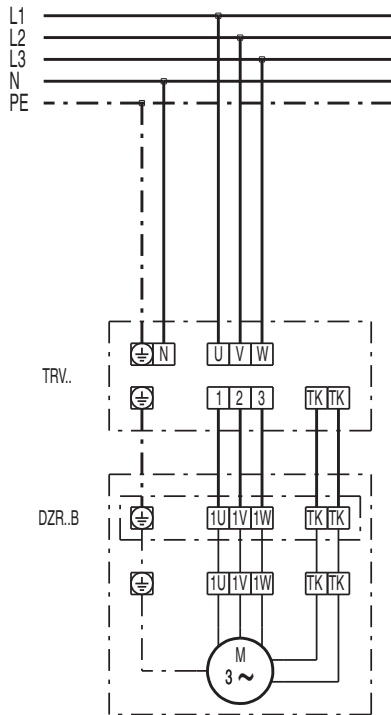

# SCHALTBILDER

## DZR 35/2 B

