

Lüftertaster/  
Lüfterschalter LTA-LSA

Vent switch LTA-LSA

DE Montageanleitung  
GB Installation instructions

120526-04



**Germany**  
GEZE Sonderkonstruktionen GmbH  
Planken 1  
97944 Boxberg-Schweigern  
Tel. +49 (0) 7930 9294 0  
Fax +49 (0) 7930 9294 10  
E-Mail: sk.de@geze.com  
GEZE GmbH  
Niederlassung Süd-West  
Tel. +49 (0) 7152 203 594  
E-Mail: leonberg.de@geze.com  
GEZE GmbH  
Niederlassung Süd-Ost  
Tel. +49 (0) 7152 203 6440  
E-Mail: muenchen.de@geze.com  
GEZE GmbH  
Niederlassung Ost  
Tel. +49 (0) 7152 203 6840  
E-Mail: berlin.de@geze.com  
GEZE GmbH  
Niederlassung Mitte/Luxemburg  
Tel. +49 (0) 7152 203 6888  
E-Mail: frankfurt.de@geze.com  
GEZE GmbH  
Niederlassung West  
Tel. +49 (0) 7152 203 6770  
E-Mail: essen.de@geze.com  
GEZE GmbH  
Niederlassung Nord  
Tel. +49 (0) 7152 203 6600  
E-Mail: hamburg.de@geze.com  
GEZE Service GmbH  
Tel. +49 (0) 1802 923392  
E-Mail: service-info.de@geze.com

**Austria**  
GEZE Austria  
E-Mail: austria.at@geze.com  
www.geze.at

**Baltic States**  
GEZE GmbH Baltic States office  
E-Mail: office-latvia@geze.com  
www.geze.com

**Benelux**  
GEZE Benelux B.V.  
E-Mail: benelux.nl@geze.com  
www.geze.be  
www.geze.nl

**Bulgaria**  
GEZE Bulgaria - Trade  
E-Mail: office-bulgaria@geze.com  
www.geze.bg

**China**  
GEZE Industries (Tianjin) Co., Ltd.  
E-Mail: chinasales@geze.com.cn  
www.geze.com.cn  
GEZE Industries (Tianjin) Co., Ltd.  
Branch Office Shanghai  
E-Mail: chinasales@geze.com.cn  
www.geze.com.cn  
GEZE Industries (Tianjin) Co., Ltd.  
Branch Office Guangzhou  
E-Mail: chinasales@geze.com.cn  
www.geze.com.cn  
GEZE Industries (Tianjin) Co., Ltd.  
Branch Office Beijing  
E-Mail: chinasales@geze.com.cn  
www.geze.com.cn

**France**  
GEZE France S.A.R.L.  
E-Mail: france.fr@geze.com  
www.geze.fr

**Hungary**  
GEZE Hungary Kft.  
E-Mail: office-hungary@geze.com  
www.geze.hu

**Iberia**  
GEZE Iberia S.R.L.  
E-Mail: info@geze.es  
www.geze.es

**India**  
GEZE India Private Ltd.  
E-Mail: office-india@geze.com  
www.geze.in

**Italy**  
GEZE Italia S.r.l.  
E-Mail: italia.it@geze.com  
www.geze.it

GEZE Engineering Roma S.r.l.  
E-Mail: roma@geze.biz  
www.geze.it

**Poland**  
GEZE Polska Sp. z o.o.  
E-Mail: geze.pl@geze.com  
www.geze.pl

**Romania**  
GEZE Romania S.R.L.  
E-Mail: office-romania@geze.com  
www.geze.ro

**Russia**  
OOO GEZE RUS  
E-Mail: office-russia@geze.com  
www.geze.ru

**Scandinavia – Sweden**  
GEZE Scandinavia AB  
E-Mail: sverige.se@geze.com  
www.geze.se

**Scandinavia – Norway**  
GEZE Scandinavia AB avd. Norge  
E-Mail: norge.se@geze.com  
www.geze.no

**Scandinavia – Denmark**  
GEZE Danmark  
E-Mail: danmark.se@geze.com  
www.geze.dk

**Singapore**  
GEZE (Asia Pacific) Pte, Ltd.  
E-Mail: gezessea@geze.com.sg  
www.geze.com

**South Africa**  
GEZE Distributors (Pty) Ltd.  
E-Mail: info@gezesa.co.za  
www.geze.co.za

**Switzerland**  
GEZE Schweiz AG  
E-Mail: schweiz.ch@geze.com  
www.geze.ch

**Turkey**  
GEZE Kapi ve Pencere Sistemleri  
E-Mail: office-turkey@geze.com  
www.geze.com

**Ukraine**  
LLC GEZE Ukraine  
E-Mail: office-ukraine@geze.com  
www.geze.ua

**United Arab Emirates/GCC**  
GEZE Middle East  
E-Mail: gezeme@geze.com  
www.geze.ae

**United Kingdom**  
GEZE UK Ltd.  
E-Mail: info.uk@geze.com  
www.geze.com

## GEZE GmbH

Reinhold-Vöster-Straße 21–29 Tel.: 0049 7152 203 0  
71229 Leonberg Fax: 0049 7152 203 310  
Germany www.geze.com



## Bezeichnung / Description

Lüftertaster/Lüfterschalter, 1-fach Rahmen AS 500 alpinweiß,  
Mat. Nr. 118476.

Vent switch, single frame AS 500 alpine white, Mat. no. 118476

## Zubehör / Accessories

Name	Mat. Nr.
AS 500 UP-Rahmen / AS 500 concealed frame	
□ 1-fach / single	115376
□ 2-fach / double	115377
□ 3-fach / triple	115378
□ 4-fach / quadruple	115379
□ 5-fach / quintuple	115380
AS 500 Aufputzdose / AS 500 Surface-mounted box	
□ 1-fach / single	120503
□ 2-fach / double	128609
□ 3-fach / triple	133206
Zwischenrahmen 55x55 für ST 550 alpinweiß / intermediate frame 55x55 for ST 550 alpine white	155851
Zwischenrahmen 55x55 für LS 990 alpinweiß / intermediate frame 55x55 for LS 990 alpine white	148997
Zwischenrahmen 55x55 für LS 990 edelstahl / intermediate frame 55x55 for LS 990 stainless steel	131822
AS 500 Blindabdeckung BAB / AS 500 dummy cover BAB	118480
SCT (1-pol.)	117996

## Passende Schalterprogramme / Matching switch ranges

Jung  
 □ AS 500  
 □ LS 990 (mit Zwischenrahmen / with intermediate frame)  
 □ ST550 (mit Zwischenrahmen / with intermediate frame)

Gira  
 □ Standard 55  
 □ E2  
 □ Event

Feller  
 □ EDIZIOdue

Merten  
 □ System M

### Berker

□ B3  
 □ B7  
 □ S1

## Technische Daten / Technical data

Variante Variant	Spannung Voltage	Strom Current
LTA-LSA	230 V AC	max. 10 A
Schutzart / Protection rating	IP 40	

## Maßzeichnungen / Dimensional drawings

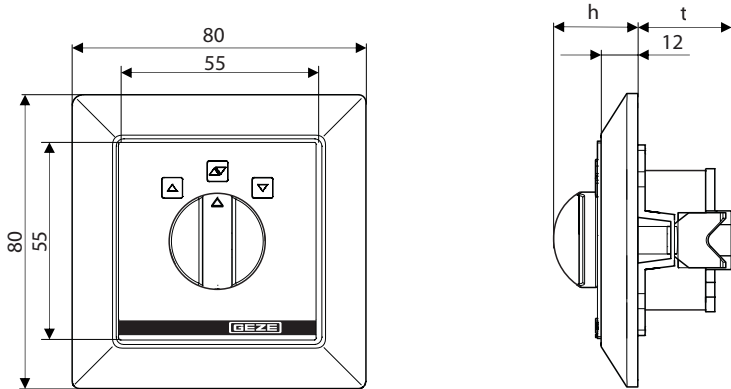

## Zusammenbau / Assembly

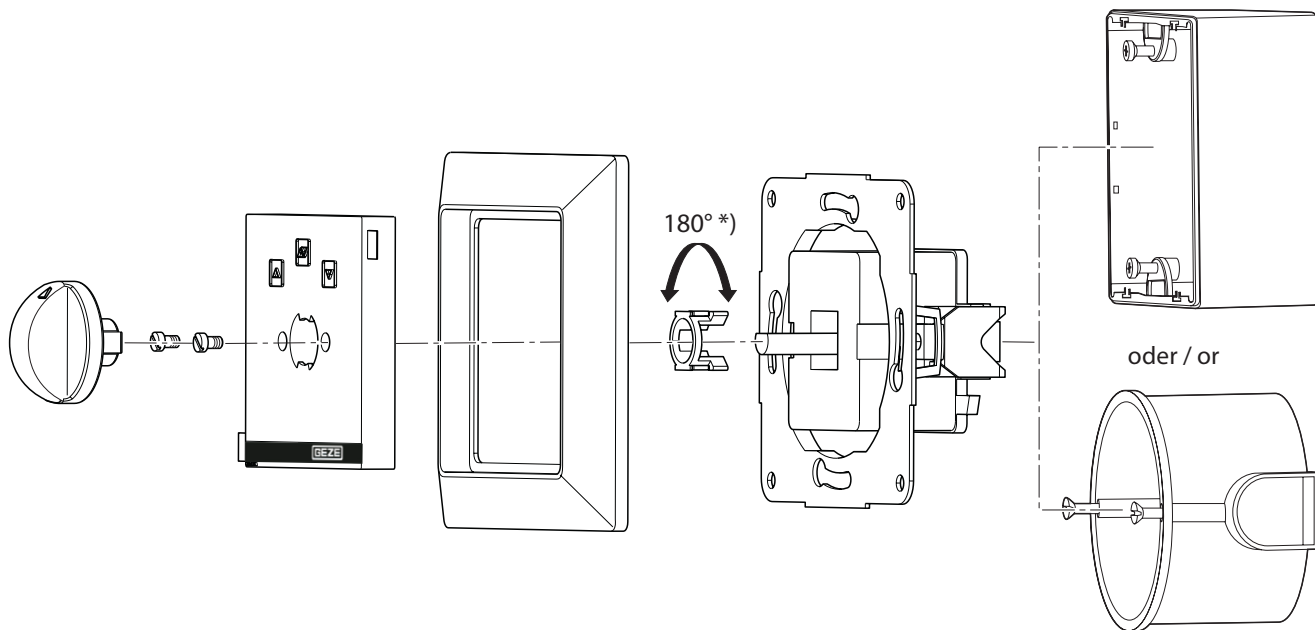

\*) wahlweise Tast- oder Rastfunktion;  
Auslieferungszustand: rastend

\*) with optional touch or latching function;  
standard delivery: latching function

# Schablone für Pfostenmontage / Template for installation on a post



Die Papierschablone kann sich abhängig von der Luftfeuchtigkeit maßlich verändern. Verbindlich sind daher nur die Maßangaben.

▶ Vor der Verwendung Papierschablone maßlich kontrollieren und ggf. korrigieren.

The dimensions of the paper template can change depending on air humidity. For this reason, only our dimensional specifications are applicable.

▶ Before using the paper template check the dimensions and correct if necessary.

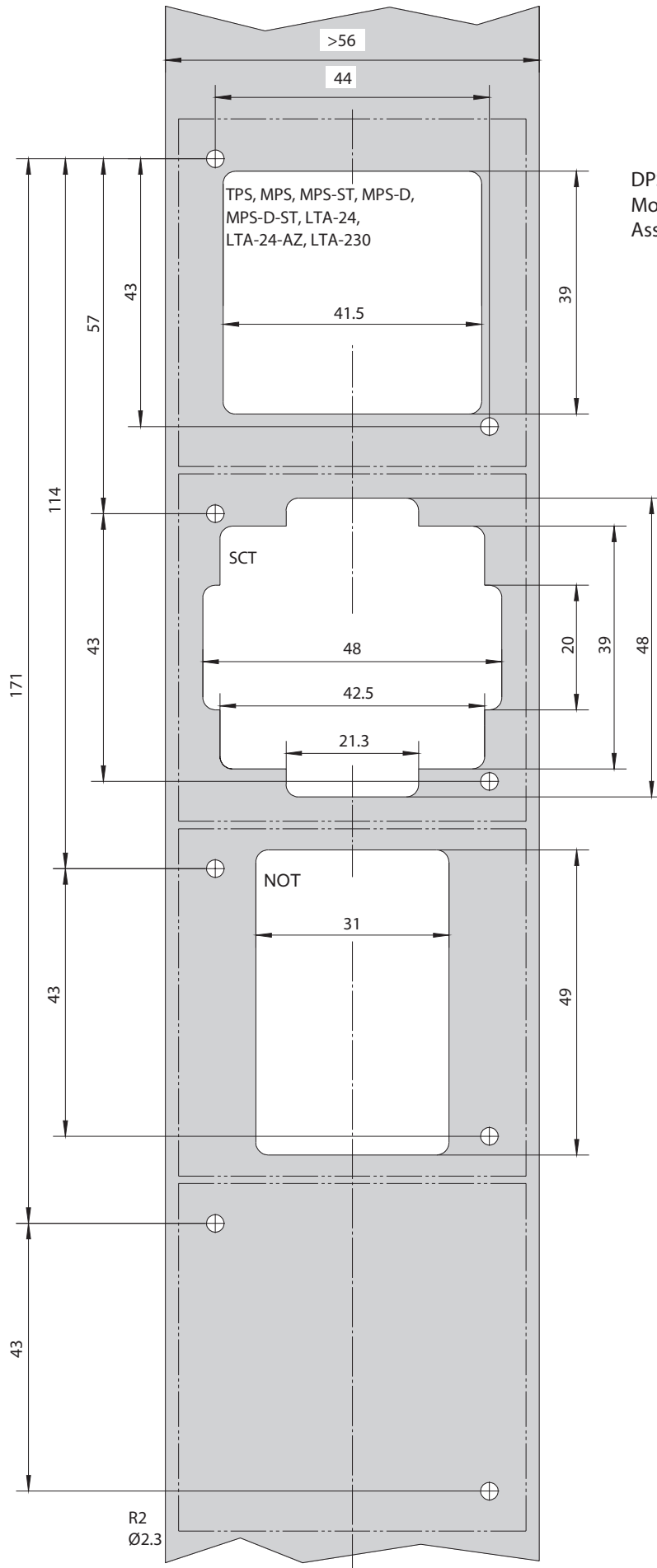

DPS, LTA-LSA:  
Montage in Pfosten nicht möglich. /  
Assembly on a post not possible.

# Schaltpläne / Circuit diagrams

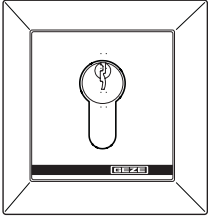
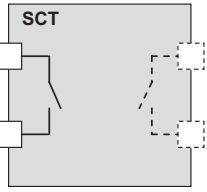
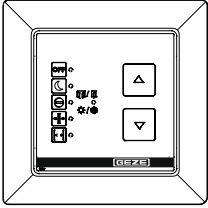
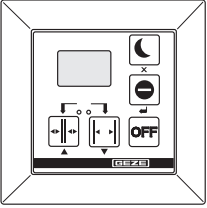
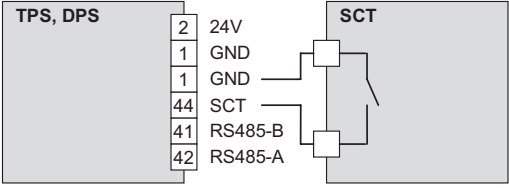
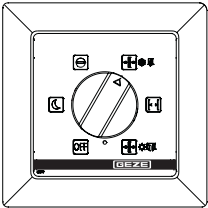
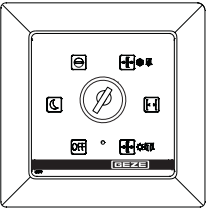
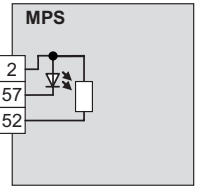
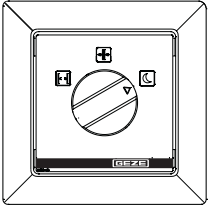
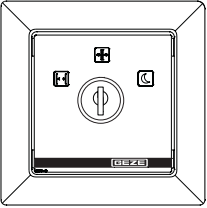
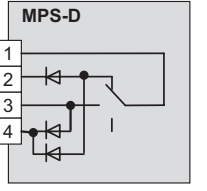
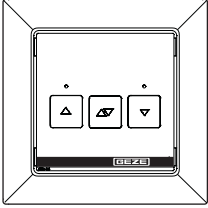
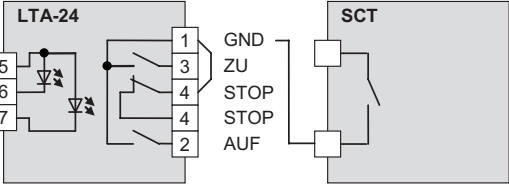
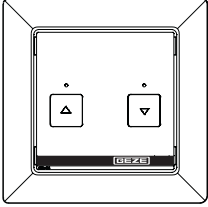
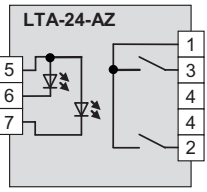
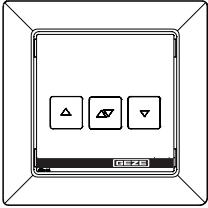
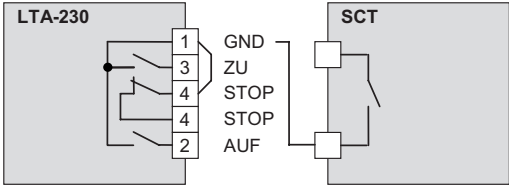
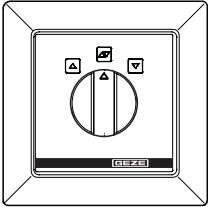
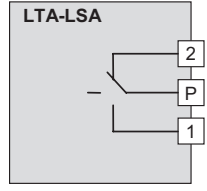
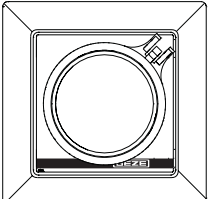
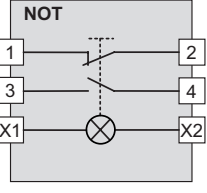
Taster / Switches	Bezeichnung / Description	Mat. Nr. / Mat.No.	Taster / Switches	Bezeichnung / Description	Mat. Nr. / Mat. No.	Schaltplan / Circuit diagram	h [mm]	t [mm]
	SCT (1-pol.)	117996		-	-		11	31.9
	TPS TPS-SCT TPS-KDT TPS-KDT-SCT DPS mit/with OFF DPS ohne/ without OFF DPS mit/with OFF SCT	113231 113232 126582 126583 151524 155809 155810		TPS, DPS			11.3	5.3 31.9
	MPS	113226		MPS-ST	113227		24	36
	MPS-D	118417		MPS-D-ST	118418		24	36
	LTA-24 LTA-24-SCT	118473 127176		LTA-24			11	26
	LTA-24-AZ	129393		LTA-24-AZ			11	26
	LTA-230 LTA-230-SCT	118474 118475		LTA-230			11	26
	LTA-LSA	118476		LTA-LSA			24	32
	NOT	123132		NOT			54	56