

Wall mounting socket outlet, fused - housing dimensions 460x180, with residual current circuit breaker



Product description	
BALS-Prd.-Nr	15170
EAN	4024941151702
product category (PG)	TE wall mounting socket outlet, fused
current (A)	125A
number of poles (P99)	5p
number of poles (P)	3p+N+PE
position of earth contact (H)	6 h
voltage (V)	200/346 up to 240/415V

Product description	
frequency (HZ)	50 and 60Hz
protection degree (SA)	IP67
colour code 1 (KF1)	red RAL 3000
Colour of appliance	Operating window smoky topaz, Hinged lid red RAL 3000, Bayonet ring grey RAL 7035, Housing screws grey RAL 7035, Housing bottom grey RAL 7035, Housing top grey RAL 7035
connection design (AT)	screw terminal as box terminal with Kontex-contact
maximum conductor size (LQ)	70.0 qmm
cable entry (KE)	top entry M40 bottom entry M50/M40
Height	512mm
Width	180mm
Depth	210mm
dimension of enclosure (GG)	460x180 mm (HxW)
material of enclosure (GM)	Polycarbonate
contact	The contact carrier is made of high temperature resistant material, the contacts are brass nickel plated

Additional technical properties	
	The cable entry is one at top and two at bottom open
	With 4 pole 125/0.3A RCCB

Logistics data	
Weight/pcs	4.028 kg / Piece

Logistics data	
Packaging	Carton
Content amount	1 ST
EAN	4024941151702
Length	560 mm
Width	215 mm
Height	260 mm
Weight	4.49 kg
Volume	26,400 ccm

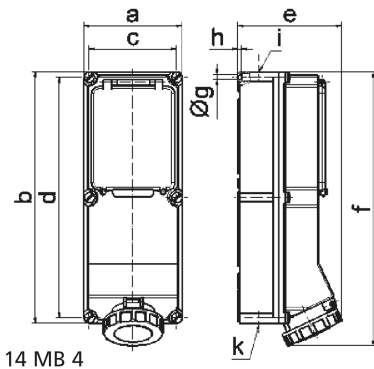

Ampere Polzahl	63 3	63 4	63 5	125 4	125 5
a	180,0	180,0	180,0	180,0	180,0
b	460,0	460,0	460,0	460,0	460,0
c	160,0	160,0	160,0	160,0	160,0
d	440,0	440,0	440,0	440,0	440,0
e	191,0	191,0	191,0	210,0	210,0
f	500,0	500,0	500,0	512,0	512,0
g Ø	8,3	8,3	8,3	8,3	8,3
h	6,5	6,5	6,5	6,5	6,5
i	M40	M40	M40	M40	M40
k	M32/40	M32/40	M32/40	M40/50	M40/50