

Han-Eco Mod.10E-SMC-MI-SCT

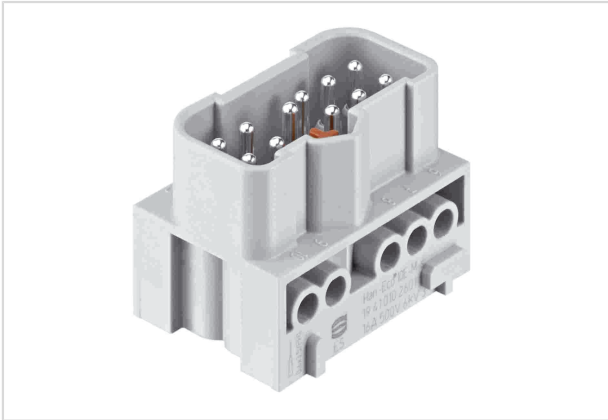

Image is for illustration purposes only. Please refer to product description.

Part number	19 41 010 2601
Specification	Han-Eco Mod.10E-SMC-MI-SCT
HARTING eCatalogue	https://b2b.harting.com/19410102601

Identification

Category	Inserts
Series	Han-Eco®

Version

Termination method	Screw termination
Gender	Male
Size	6 B
With wire protection	Yes
Number of contacts	10
PE contact	Yes

Technical characteristics

Conductor cross-section	0.75 ... 2.5 mm ²
Rated current	16 A
Rated voltage	500 V
Rated impulse voltage	6 kV
Pollution degree	3
Rated voltage acc. to UL	600 V
Rated voltage acc. to CSA	600 V
Insulation resistance	>10 ¹⁰ Ω
Tightening torque	0.5 Nm
Limiting temperature	-40 ... +125 °C



Pushing Performance
Since 1945

Technical characteristics

Mating cycles	≥500
---------------	------

Material properties

Material (insert)	Polycarbonate (PC)
Colour (insert)	RAL 7032 (pebble grey)
Material (contacts)	Copper alloy
Surface (contacts)	Silver plated
Material flammability class acc. to UL 94	V-0
RoHS	compliant with exemption
RoHS exemptions	6(c): Copper alloy containing up to 4 % lead by weight
ELV status	compliant with exemption
China RoHS	50
REACH Annex XVII substances	Not contained
REACH ANNEX XIV substances	Not contained
REACH SVHC substances	Yes
REACH SVHC substances	Lead
ECHA SCIP number	5dbb3851-b94e-4e88-97a1-571845975242
California Proposition 65 substances	Yes
California Proposition 65 substances	Lead Nickel
Fire protection on railway vehicles	EN 45545-2 (2020-08)
Requirement set with Hazard Levels	R22 (HL 1-3) R23 (HL 1-3)

Commercial data

Packaging size	1
Net weight	44.8 g
Country of origin	Romania
European customs tariff number	85366990
GTIN	5713140130906
eCl@ss	27440205 Contact insert for industrial connectors