

Artikel-Nr.	3932-2f9v
Bezeichnung	CEE-Anbausteckdose gerade 54x60mm 32A 3p 24/42VAC 300Hz IP66/IP67 TWIST
Langbeschreibung	CEE-Anbausteckdose gerade 54x60mm 32A 3p 24/42VAC 300Hz IP66/IP67 TWIST Gehäusematerial: PA6 Nennstrom: 32A Polzahl: 3 (3P) Uhrzeit-Stellung: 2h Nennspannung/Frequenz: 24/42V~ / 300Hz Kontakte: Messing vernickelt Anschlusstechnik: Schraubklemmen Abmessungen (Flansch/Bohrung): 54x60 mm / 44x44 mm Schutzart: IP66/IP67
GTIN (EAN)	9003399363085
Ursprungsland	AT
Zolltarifnummer	85366990
Nettogewicht	0,156 kg
Verpackungsmenge	10
Mindestbestellmenge	10

ETIM 9.0	EC001317
IEC-Stromstärke	32 A
Spannung nach EN 60309-2	20-25 V / 40-50 V (300 Hz) grün
Polzahl	3
Uhrzeit-Stellung	2 h
Kennfarbe	grün
Schutzart (IP)	IP67
Anschlusstechnik	Schraubklemme
Steckrichtung	gerade
Werkstoff	Kunststoff
Flanschmaß vertikal	60 mm
Bohrlochabstand vertikal	44 mm
Flanschmaß horizontal	54 mm
Bohrlochabstand horizontal	44 mm

a	54 mm
b	60 mm
c	44 mm
d	44 mm
e	19 mm
f	48 mm
g	5,5 mm
h	43 mm
i	100 mm
j	93 mm
Leitung flexibel	1-10 mm ²
Leitung starr	1,5-10 mm ²
Kontaktschrauben	160 Ncm
Abmantelungslänge	70 mm
Abisolierlänge	14-16 mm
Umgebungstemperatur	-25 – 40 °C
Temperaturbeständigkeit	-25 – 80 °C

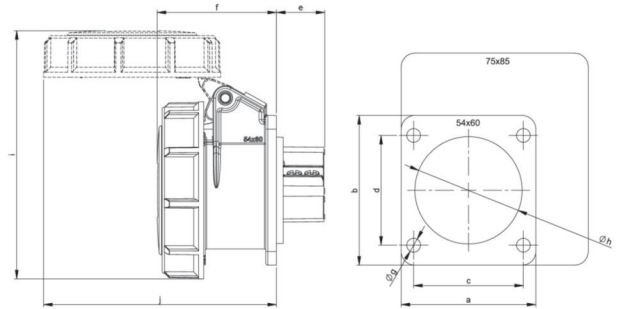

<https://www.pcelectric.at/shop/de/?func=detail&artnr=3932-2f9v>

