

Surface-mounting distributor, rubber - MODBOX

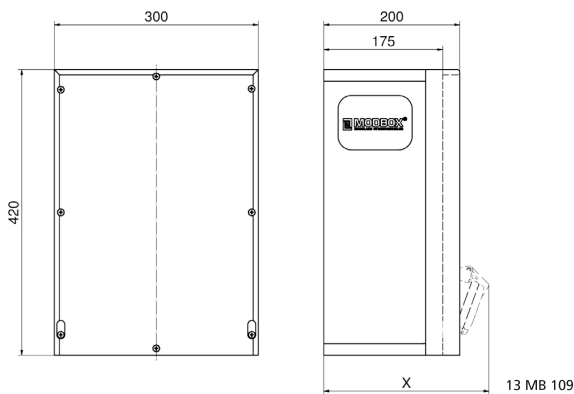

Product description	
BALS-Prd.-Nr	5402164
EAN	4024941948784
product category (PG)	MODBOX
protection degree (SA)	IP67
Colour of appliance	Housing bottom similar black RAL 9017, Housing top similar black RAL 9017
Height	420mm
Width	300mm
Depth	200mm

Logistics data	
Weight/pcs	14.438 kg / Piece
Packaging	Carton
Content amount	1 ST
EAN	4024941948784
Length	320 mm
Width	346 mm
Height	511 mm
Weight	15.148 kg
Volume	56,577.92 ccm

Tiefenmaß/ depth X (mm)

Bezeichnung/ with	IP44	IP67
Schutzk. Steckdose/domestic socket	192	235
CEE 16A 3p	230	230
CEE 16A 4p	234	232
CEE 16A 5p	237	235
CEE 32A 3p/4p	241	243
CEE 32A 5p	243	244
CEE 63A 3p/4p/5p	259	261