

Panel mounting socket outlet - straight execution, flange 55x55, fixing centers 45x45



Product description	
BALS-Prd.-Nr	437
EAN	4024941004374
Product category	Panel mounting socket outlet, extra-low voltage, straight
Current	16A
Number of poles	3p
Poles	3P
Position of earth contact	12 h
Voltage	40 up to 50V

Product description	
Frequency	50 and 60Hz
Protection degree	IP44
Colour code	gray RAL 7035
Colour of appliance	Hinged lid grey RAL 7035, Enclosure grey RAL 7035
Connection design	with screw terminal
Maximum conductor size	10,0 qmm
Cable entry	other
Height	67mm
Width	55mm
Depth	59mm
Flange size vertical	55mm
Flange size horizontal	55mm
Drill hole distance vertical	45mm
Drill hole distance horizontal	45mm
Material of enclosure	Polyamide
Contact	The contact carrier is made of polyamide, the contacts are brass nickel plated

Logistics data	
Weight/pcs	0.126 kg / Piece
Packaging	Bag
Content amount	1 ST

Logistics data	
EAN	4024941004374
Length	59 mm
Width	55 mm
Height	67 mm
Weight	0.127 kg
Volume	217.415 ccm
Packaging	Carton
Content amount	10 ST
EAN	4024941968812
Length	207 mm
Width	162 mm
Height	142 mm
Weight	1.36 kg
Volume	3,750 ccm

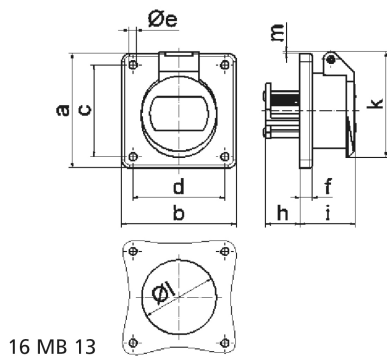

Ampere Polzahl	16 2	16 3	32 2	32 3		
a	55,0	55,0	55,0	55,0		
b	55,0	55,0	55,0	55,0		
c	45,0	45,0	45,0	45,0		
d	45,0	45,0	45,0	45,0		
e Ø	5,2	5,2	5,2	5,2		
f	6,0	6,0	6,0	6,0		
h	22,0	22,0	22,0	22,0		
i	37,0	37,0	37,0	37,0		
k	67,0	67,0	67,0	67,0		
l Ø	49,0	49,0	49,0	49,0		
m	12,0	12,0	12,0	12,0		
Leiter mm ² min	4	4	4	4		
Leiter mm ² max	10	10	10	10		