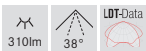
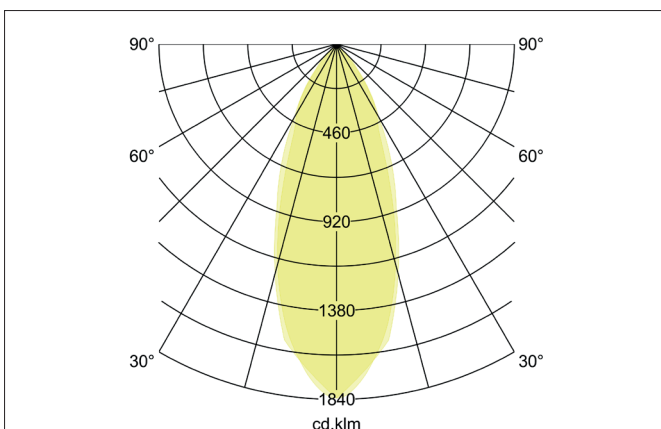
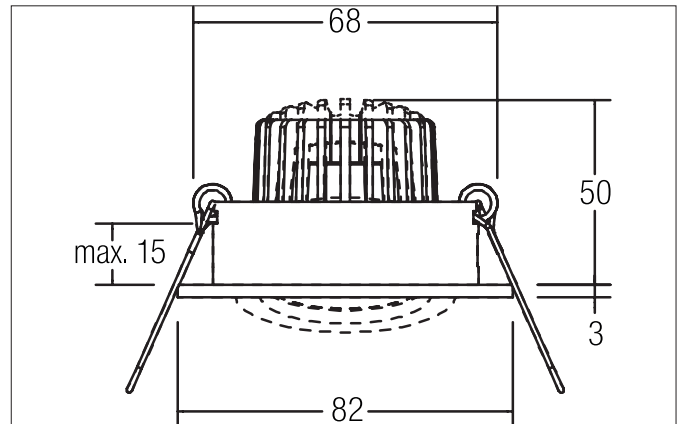
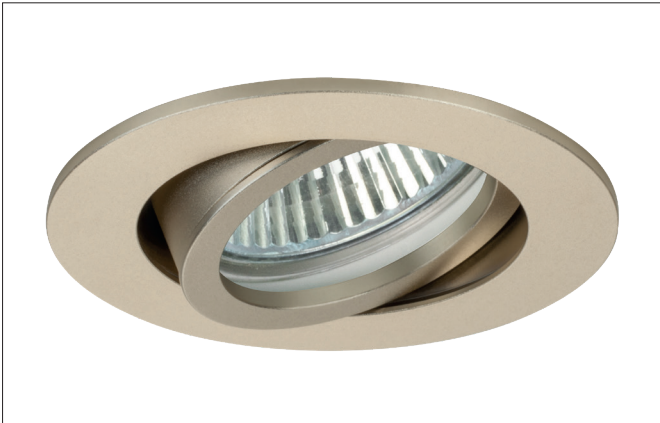

**PAYTON-R LED recessed spot**

Article no. 12373633

Light.  
For Generations.**Tender**

LED recessed spot, Round. Toolless ceiling installation by installation springs. Ceiling cut-out Ø 68 mm, Installation depth 50 mm, Outer diameter 82 mm, Weight 0,140 kg, Reflector silver with rotationssymmetrical, deep, wide distributed light intensity. optimal light distribution due to a glass transparent cover. Luminous flux 310 lm, Power 1 x 3 W, System Efficiency 103 lm/W, Light colour warm white, Correlated color temperature (CCT) 3.000 K, Colour rendering index CRI > 80, Housing material: Aluminium / Glass, Colour: Champagne, Permissible ambient temperature (ta): -20 °C - +25 °C, Protection class (EN 61140): III, Degree of protection (DIN EN 60529): IP20. For connection to an external driver, which is not included in the scope of delivery of the luminaire. Depending on driver dimmable.

**Product Benefits**

- Round recessed spotlight made of solid aluminum with glass cover.
- Easy and tool-free mounting.
- CRI > 80.
- Low installation depth 50 mm, diameter 82 mm, Ceiling cut-out 68 mm.
- Ceiling thickness maximum 13 mm.
- Large article variance in terms of housing color and color temperature.
- Power supply with 350 mA.
- Alternatively available in square design.

**PAYTON-R LED recessed spot**

Article no. 12373633

Light.  
For Generations.

Article data	
Article no.	12373633
GTIN	4251433946540
Series name	PAYTON-R
Short description	LED recessed spot
Material	Aluminium / Glass
Colour	Champagne
Type of surface	Matt
Shape	Round
Outer diameter	82 mm
Built-in diameter	68 mm
Installation depth	50 mm
Hight	3 mm
Weight	0.140 kg

Lighting technology	
Colour temperature	3.000 K
Light colour	White
Light output	Direct
Luminous flux	310 lm
System efficiency	103 lm/W
Colour rendering	CRI > 80
Reflector	High-gloss
Reflektorfarbe	silver
Beam angle	38°
Light sharing	Symmetric

Operating technology of the luminaire	
Voltage type	DC
Current	350 mA
Lamp	LED
Lamp holder	Plug&Play
Protection class	III
Degree of protection	IP20
Dimmable	Depending on type of control gear
Control	Depending on driver
Bulb change possible	The light source of this luminaire may only be replaced by the manufacturer or a service technician commissioned by him or a similarly qualified person.

Mounting technology	
Mounting method	Recessed mounting
Place of installation	Ceiling-mounted
Adjustability	Pivoted
Swivel angle	20°
Max. ceiling thickness	13 mm
Further references	No cover with thermal insulation material
Material cover	Glass transparent
Circlip	Without circlip

**PAYTON-R LED recessed spot**

Article no. 12373633

Light.  
For Generations.

Packing data	
Gross weight	0.213 kg
Length of packaging	100 mm
Packaging width	100 mm
Packaging height	100 mm
Disposal at end of life	<p>This product must not be disposed of with household waste. You are obliged, to dispose of such electrical waste separately.</p> <p>By disposing of electrical waste and other old or defective electronics separately, you support recycling or other forms of re-use. In that way you help to take care and to avoid that harmful substances get into the environment.</p>

## PAYTON-R LED recessed spot

Article no. 12373633

Light.  
For Generations.

Accessories	
	<p>Article no.: 17666000 LED converter 350 mA, on/off switchable Power: 1 - 5 W Dimensions: 52 mm x 30 mm x 23 mm</p>
	<p>Article no.: 17662000 LED converter 350 mA, on/off switchable Power: 1 - 7,2 W Dimensions: 68 mm x 35 mm x 21 mm</p>
	<p>Article no.: 17662010 LED converter 350 mA, on/off switchable Power: 1 - 7,2 W Dimensions: 68 mm x 35 mm x 21 mm</p>
	<p>Article no.: 17662020 LED converter 350 mA, on/off switchable Power: 1 - 7,2 W Dimensions: 68 mm x 35 mm x 21 mm</p>
	<p>Article no.: 17613000 LED converter 350 mA, on/off switchable Power: 1 - 15 W Dimensions: 115 mm x 34 mm x 19 mm</p>
	<p>Article no.: 17613010 LED converter 350 mA, on/off switchable Power: 1 - 15 W Dimensions: 115 mm x 34 mm x 19 mm</p>
	<p>Article no.: 17613020 LED converter 350 mA, on/off switchable Power: 1 - 15 W Dimensions: 115 mm x 34 mm x 19 mm</p>
	<p>Article no.: 17621000 LED converter 350 mA, on/off switchable Power: 1 - 21 W Dimensions: 128 mm x 50 mm x 13 mm</p>
	<p>Article no.: 17621010 LED converter 350 mA, on/off switchable Power: 1 - 21 W Dimensions: 128 mm x 50 mm x 13 mm</p>
	<p>Article no.: 17621020 LED converter 350 mA, on/off switchable Power: 1 - 21 W Dimensions: 128 mm x 50 mm x 13 mm</p>

**PAYTON-R LED recessed spot**

Article no. 12373633



Light.  
For Generations.

Accessories	
	Article no.: 17663000 LED converter 350 mA, trailing-edge phase dimmable Power: 2,8 - 7 W Dimensions: 110 mm x 50 mm x 19 mm
	Article no.: 17663010 LED converter 350 mA, trailing-edge phase dimmable Power: 2,8 - 7 W Dimensions: 110 mm x 50 mm x 19 mm
	Article no.: 17663020 LED converter 350 mA, trailing-edge phase dimmable Power: 2,8 - 7 W Dimensions: 110 mm x 50 mm x 19 mm
	Article no.: 17648000 LED converter 350 mA, trailing-edge phase dimmable Power: 0,7 - 17 W Dimensions: 166 mm x 46 mm x 34 mm
	Article no.: 17648010 LED converter 350 mA, trailing-edge phase dimmable Power: 0,7 - 17 W Dimensions: 166 mm x 46 mm x 34 mm
	Article no.: 17648020 LED converter 350 mA, trailing-edge phase dimmable Power: 0,7 - 17 W Dimensions: 166 mm x 46 mm x 34 mm
	Article no.: 17684000 LED converter 350 mA, DALI dimmable (digital) Power: 2,8 - 7 W Dimensions: 130 mm x 42 mm x 22 mm
	Article no.: 17684010 LED converter 350 mA, DALI dimmable (digital) Power: 2,8 - 7 W Dimensions: 130 mm x 42 mm x 22 mm
	Article no.: 17684020 LED converter 350 mA, DALI dimmable (digital) Power: 2,8 - 7 W Dimensions: 130 mm x 42 mm x 22 mm
	Article no.: 17658000 LED round converter 350 mA, DALI dimmable (digital) Power: 2,1 - 9 W Dimensions: 56 mm x 25 mm
	Article no.: 17658010 LED round converter 350 mA, DALI dimmable (digital) Power: 2,1 - 9 W Dimensions: 56 mm x 25 mm

**PAYTON-R LED recessed spot**

Article no. 12373633

Light.  
For Generations.

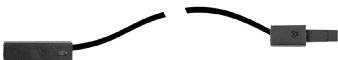
Accessories	
	<p>Article no.: 17658020 LED round converter 350 mA, DALI dimmable (digital) Power: 2,1 - 9 W Dimensions: 56 mm x 25 mm</p>
	<p>Article no.: 3835 Plug &amp; Play extension lead 350 mA Dimensions: 500 mm</p>
	<p>Article no.: 3836 Plug &amp; Play extension lead 350 mA Dimensions: 1,000 mm</p>
	<p>Article no.: 3837 Plug &amp; Play extension lead 350 mA Dimensions: 2,000 mm</p>