

LED reflector insert MR16, 6 W, 350 mA  
Article no. 12923603

Light.  
For Generations.

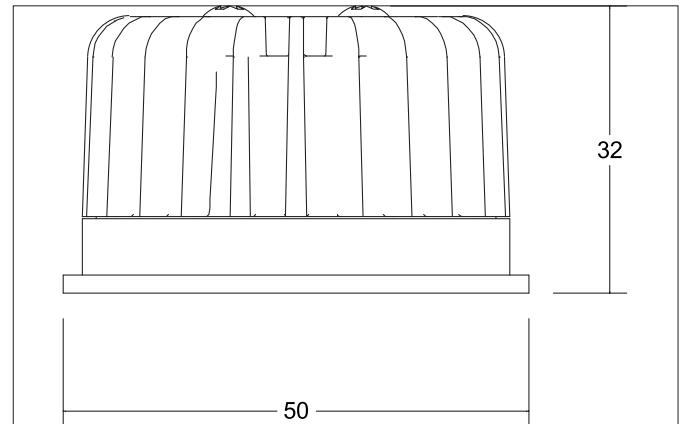

#### Tender

LED reflector insert MR16, 6 W, 350 mA, Round. Ceiling cut-out Installation depth mm, Outer diameter 50 mm, Weight 0,078 kg, with rotationssymmetrical, deep, wide distributed light intensity. with Lamp holder Plug&Play max: 6 W, Delivery without bulb. Housing material: Aluminium / Glass, Colour:, Permissible ambient temperature (ta): -20 °C - +25 °C, Protection class (EN 61140): III, Degree of protection (DIN EN 60529): IP20. For direct connection to mains voltage, Dimming depending on driver dimmable.

| Article data      |                                        |
|-------------------|----------------------------------------|
| Article no.       | 12923603                               |
| GTIN              | 4251433936244                          |
| Short description | LED reflector insert MR16, 6 W, 350 mA |
| Material          | Aluminium / Glass                      |
| Colour            |                                        |
| Shape             | Round                                  |
| Outer diameter    | 50 mm                                  |
| Hight             | 32 mm                                  |
| Weight            | 0.078 kg                               |

LED reflector insert MR16, 6 W, 350 mA  
Article no. 12923603

Light.  
For Generations.











| Lighting technology |            |
|---------------------|------------|
| Colour temperature  | 2700 K     |
| Light colour        | White      |
| Luminous flux       | 570 lm     |
| System efficiency   | 95 lm/W    |
| Colour rendering    | CRI > 80   |
| Reflector           | High-gloss |
| Beam angle          | 60°        |
| Light sharing       | Symmetric  |

| Operating technology of the luminaire |                             |
|---------------------------------------|-----------------------------|
| Voltage type                          | DC                          |
| Current                               | 350 mA                      |
| Lamp                                  | LED                         |
| Lamp holder                           | Plug&Play                   |
| Protection class                      | III                         |
| Degree of protection                  | IP20                        |
| Control                               | Dimming depending on driver |
| Bulb change possible                  | Yes                         |
| Rated life time L80/B20 at 25 °C      | 50.000 h                    |

| Packing data            |                                                                                                                                                                                                                                                                                                                                                                     |
|-------------------------|---------------------------------------------------------------------------------------------------------------------------------------------------------------------------------------------------------------------------------------------------------------------------------------------------------------------------------------------------------------------|
| Gross weight            | 0.089 kg                                                                                                                                                                                                                                                                                                                                                            |
| Length of packaging     | 55 mm                                                                                                                                                                                                                                                                                                                                                               |
| Packaging width         | 55 mm                                                                                                                                                                                                                                                                                                                                                               |
| Packaging height        | 65 mm                                                                                                                                                                                                                                                                                                                                                               |
| Disposal at end of life | This product must not be disposed of with household waste. You are obliged, to dispose of such electrical waste separately.<br>By disposing of electrical waste and other old or defective electronics separately, you support recycling or other forms of re-use. In that way you help to take care and to avoid that harmful substances get into the environment. |

LED reflector insert MR16, 6 W, 350 mA  
Article no. 12923603

Light.  
For Generations.

| Accessories                                                                         |                                                                                                                                        |
|-------------------------------------------------------------------------------------|----------------------------------------------------------------------------------------------------------------------------------------|
|    | Article no.: 17662020<br>LED converter 350 mA, on/off switchable<br>Power: 1 - 7,2 W<br>Dimensions: 68 mm x 35 mm x 21 mm              |
|    | Article no.: 17613000<br>LED converter 350 mA, on/off switchable<br>Power: 1 - 15 W<br>Dimensions: 115 mm x 34 mm x 19 mm              |
|    | Article no.: 17621020<br>LED converter 350 mA, on/off switchable<br>Power: 1 - 21 W<br>Dimensions: 128 mm x 50 mm x 13 mm              |
|    | Article no.: 17663020<br>LED converter 350 mA, trailing-edge phase dimmable<br>Power: 2,8 - 7 W<br>Dimensions: 110 mm x 50 mm x 19 mm  |
|   | Article no.: 17652020<br>LED-round converter 350 mA, trailing-edge phase dimmer<br>Power: 4,9 - 7 W<br>Dimensions: 51 mm x 24 mm       |
|  | Article no.: 17640020<br>LED converter 350 mA, trailing-edge phase dimmable<br>Power: 4,2 - 10 W<br>Dimensions: 102 mm x 38 mm x 21 mm |
|  | Article no.: 17657000<br>LED converter 350 mA, 1-10 V dimmable (analog)<br>Power: 5,2 - 18 W<br>Dimensions: 110 mm x 52 mm x 22 mm     |
|  | Article no.: 17683020<br>LED converter 350 mA, DALI dimmable (digital)<br>Power: 3,5 - 17 W<br>Dimensions: 110 mm x 52 mm x 22 mm      |
|  | Article no.: 17648020<br>LED converter 350 mA, trailing-edge phase dimmable<br>Power: 0,7 - 17 W<br>Dimensions: 166 mm x 46 mm x 34 mm |
|  | Article no.: 17671020<br>LED converter 350mA, ZigBee dimmable<br>Power: 3,5 - 18,5 W<br>Dimensions: 146 mm x 44 mm x 30 mm             |