

- a) Universalboden drehbar
- b) Durchgangslotch ausbrechbar

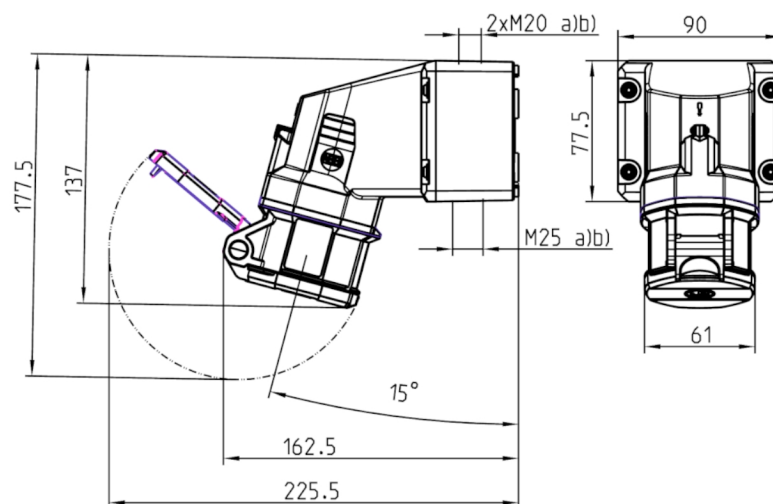

Uhrzeitstellung: 3h

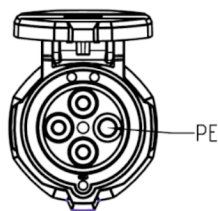

Bohrbild a)

